



Schienale sempre opaco bianco.  
La finitura da specificare si riferisce solo alle mensole  
*Back always opaque white.*  
Finish to be specified only refers to the shelves  
Trasera siempre en blanco mate.  
El acabado a especificar se refiere sólo a los estantes  
*Dosseret toujours blanc mat.*  
La finition à préciser se réfère seulement aux tablettes



Mensola sempre opaco bianco.  
La finitura da specificare si riferisce solo al frontale  
*Shelves always opaque white.*  
Finish to be specified only refers to the frontal piece  
Estante siempre en blanco mate.  
El acabado a especificar se refiere sólo al frontal  
*Tablette toujours blanc mat.*  
La finition à préciser se réfère seulement au frontal



Le cerniere sono in acciaio e con sistema di chiusura rallentato  
*The hinge are made in steel and they have slowly closing sistem*  
Las bisagras es en acero y tiene un sistema de cierre lento  
*Les charnières sont en acier et avec système de fermeture freinant*



Il sistema frenante delle guide in acciaio ad estrazione totale, rende confortevole la chiusura dei cassetti  
*The controlled closure system of the total extractable steel drawer slides, makes closing the drawers comfortable*  
El sistema de frenado de las guías de acero de extracción total faciilita enormemente el cierre de los cajones  
*Le système de freinage des guides en acier à extraction totale, rend la fermeture des tiroirs confortable*



Specchi con illuminazione fluorescente (neon) e interruttore  
*Mirrors with fluorescent lighting (neon) and switch*  
Espejos con iluminación fluorescente (neon) y interruptor  
*Miroir avec éclairage fluorescent (néon) et interrupteur*



Specchi contenitori con illuminazione fluorescente (neon), presa e interruttore  
*Mirrored cabinet with fluorescent lighting (neon), socket and switch*  
Espejos contenedores con iluminación fluorescente (neón), enchufe e interruptor  
*Armoires de toilette avec éclairage fluorescent (néon), prise et interrupteur*



Pensili con apertura premi-apri  
*Wall units with push-opening system*  
Muebles colgantes con apertura PUSH  
*Éléments haut avec ouverture à déclic*

**INDA srl MOBILI**  
Via Postumia ovest, 72  
I - 31050 Olmi (TV)  
tel. +39 0331 1828 111  
fax +39 0422 899 688  
[www.inda.net](http://www.inda.net)  
[info@inda.net](mailto:info@inda.net)

**INDA srl**  
Via Gabriele d'Annunzio, 2  
I - 21010 Vizzola Ticino (VA)  
tel. +39 0331 1828 111  
fax +39 0331 1828 112  
[www.inda.net](http://www.inda.net)  
[info@inda.net](mailto:info@inda.net)



Consumi ridotti e sicurezza per la lampada con luce LED certificata TÜV, CE e IP44  
*Safety and reduced power consumption guaranteed by the lamp with LED light, certified TÜV, CE and IP44*  
Consumos reducidos y seguridad para la lámpara con luz LED certificada TÜV, CE y IP44  
*Consommations réduites et sécurité pour la lampe à lumière LED, certifiée TÜV, CE et IP44*

**INDA FRANCE**  
8, Parc Ariane - Bâtiment Jupiter  
78284 Guyancourt cx  
tel. +33 (0)1 76 74 71 00  
fax +33 (0)1 76 74 71 11  
[www.inda.net](http://www.inda.net)  
[info@inda.net](mailto:info@inda.net)

**INDA ESPAÑA**  
Vilamarí, 86-88, Bajos  
08015 - Barcelona  
tel. +34 914 141 884/886  
fax +33 914 141 885/887  
[www.inda.net](http://www.inda.net)  
[info@inda.net](mailto:info@inda.net)





# SMILE



Lavabo integrato in ceramica bianco, completo di scarico troppopieno  
*Integrated washbasin with overflow in white ceramic*  
 Lavabo integrado en cerámica blanca con rebosadero  
*Vasque intégrée en céramique blanche, complétée du trop-plein*

Maniglia integrata nell'anta  
*Integrated handle*  
 Tirador integrado en la puerta  
*Poignée intégrée dans la porte*

Codice articolo da completare con referenze colore  
*Article code to complete with reference colour*  
 El código artículo debe completarse con las referencias del color  
*Ejemplo B160010 LL FR120*  
 Code de l'article à compléter avec les références de la couleur  
*Exemple B160010 LL FR120*

## BASI PORTA LAVABO - BASE UNITS FOR WASHBASIN - BASE PARA LAVABO - MEUBLES SOUS-VASQUE

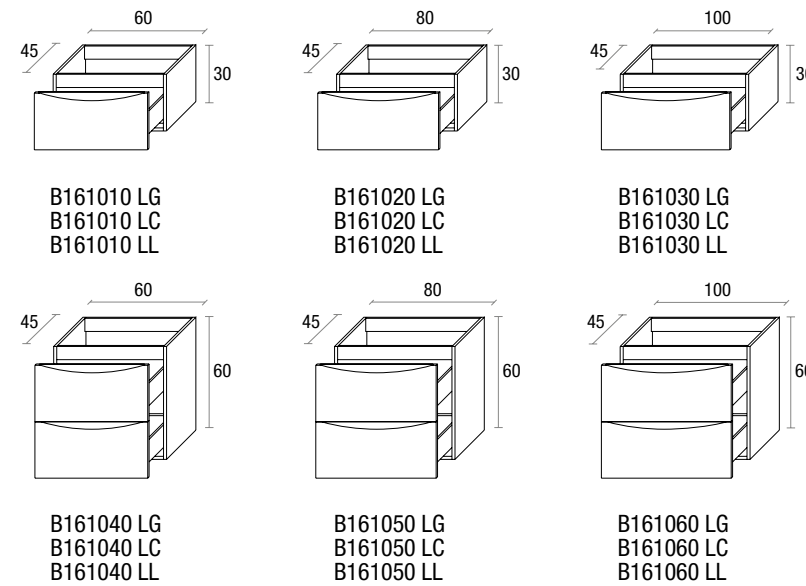

B161010 LG  
 B161010 LC  
 B161010 LL

B161020 LG  
 B161020 LC  
 B161020 LL

B161030 LG  
 B161030 LC  
 B161030 LL

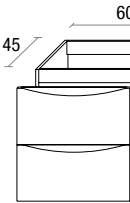

B161040 LG  
 B161040 LC  
 B161040 LL

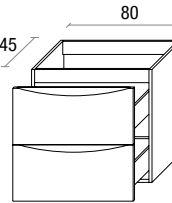

B161050 LG  
 B161050 LC  
 B161050 LL

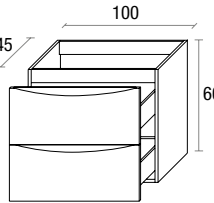

B161060 LG  
 B161060 LC  
 B161060 LL

## PIEDINI - FEET - PATAS - PIEDS

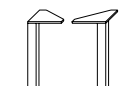

V101210

In alluminio satinato per basi H 60 cm  
*Brushed aluminum legs on H 60 cm bases only*  
 En aluminio satinado para bases de altura 60 cm  
*En aluminium satiné pour meubles H 60 cm*

## LAVABI - WASHBASINS - LAVABOS - VASQUES

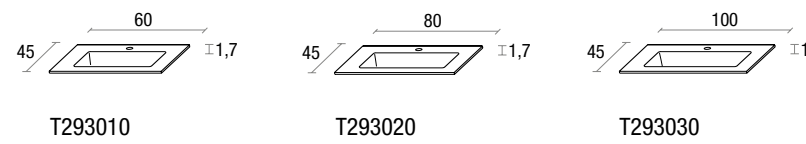

T293010

T293020

T293030

Lavabo integrato in ceramica bianco  
*Integrated washbasin in white ceramic*  
 Lavabo integrado en cerámica blanca  
*Vasque intégrée en céramique blanche*

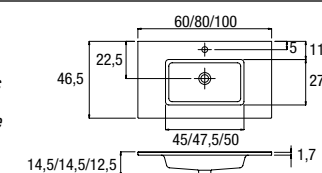

## COLONNE, PENSILI, VANO A GIORNO e MENSOLE - COLUMNS, WALL UNITS, OPEN COMPARTMENT and SHELVES COLUMNAS, MUEBLES ALTOS, MUEBLE DECORATIVO y REPISAS - COLONNES, ÉLÉMENTS HAUTS, MEUBLE OUVERT et ÉTAGÈRES

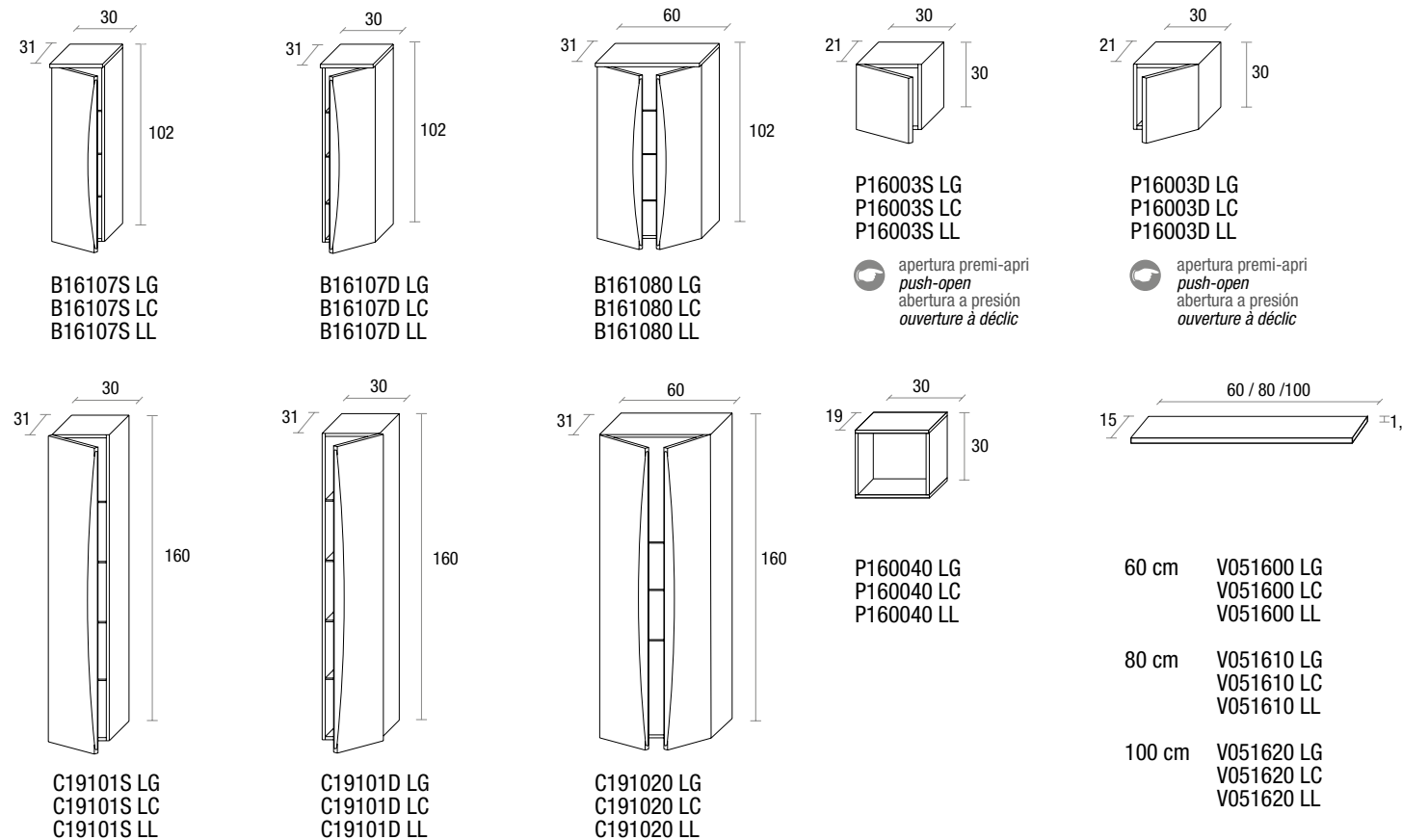

B16107S LG  
 B16107S LC  
 B16107S LL

B16107D LG  
 B16107D LC  
 B16107D LL

B161080 LG  
 B161080 LC  
 B161080 LL

P16003S LG  
 P16003S LC  
 P16003S LL

P16003D LG  
 P16003D LC  
 P16003D LL

apertura premi-apri  
*push-open*  
 abertura a presión  
*ouverture à déclic*

apertura premi-apri  
*push-open*  
 abertura a presión  
*ouverture à déclic*

C19101S LG  
 C19101S LC  
 C19101S LL

C19101D LG  
 C19101D LC  
 C19101D LL

C191020 LG  
 C191020 LC  
 C191020 LL

P160040 LG  
 P160040 LC  
 P160040 LL

60 cm V051600 LG  
 V051600 LC  
 V051600 LL

80 cm V051610 LG  
 V051610 LC  
 V051610 LL

100 cm V051620 LG  
 V051620 LC  
 V051620 LL

Inda si riserva, a proprio insindacabile giudizio, di apportare modifiche anche senza preavviso allo scopo di migliorare la produzione  
*Inda reserves the right to modify the products without advance notice in order to improve our production*  
 Inda se réserve le droit, à tout moment et à son jugement sans appel, d'apporter des modifications sans préavis, afin d'améliorer la production  
*Inda se reserva el derecho de realizar, sin previo aviso, las modificaciones que considere convenientes para mejorar el producto*

## MENSOLE - SHELVES - REPISAS - ÉTAGÈRES

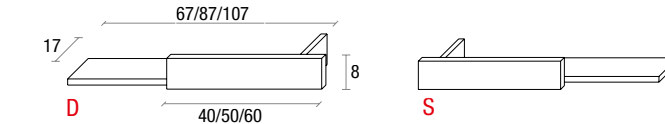

67 cm

V05163D LG / V05163S LG  
 V05163D LC / V05163S LC  
 V05163D LL / V05163S LL

87 cm

V05164D LG / V05164S LG  
 V05164D LC / V05164S LC  
 V05164D LL / V05164S LL

107 cm

V05165D LG / V05165S LG  
 V05165D LC / V05165S LC  
 V05165D LL / V05165S LL

Mensola sempre opaco bianco  
 La finitura da specificare si riferisce solo al frontale  
*Shelves always opaque white*  
 Estante siempre en blanco mate  
 El acabado a especificar se refiere sólo al frontal  
*Tablette toujours blanc mat*  
 La finition à préciser se réfère seulement au frontal

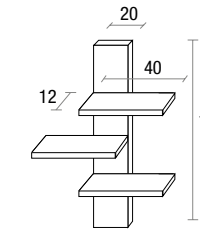

P304020 LG  
 P304020 LC  
 P304020 LL

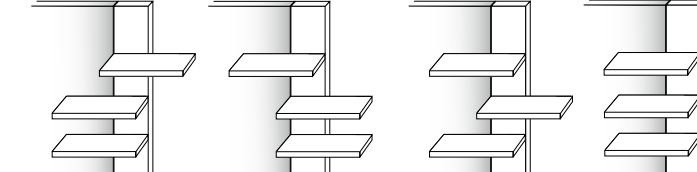

Posizione mensola a scelta - *Shelves positioning available*  
 Se puede elegir la posición de los estantes - *Position tablettas au choix*

Schienale sempre opaco bianco  
 La finitura da specificare si riferisce solo alle mensole  
*Back always opaque white*  
 Traserá siempre en blanco mate  
 El acabado a especificar se refiere sólo a los estantes  
*Dossieret toujours blanc mat*  
 La finition à préciser se réfère seulement aux tablettes

## SPECCHI e LAMPADE - MIRRORS and LAMPS - ESPEJOS y LÁMPARAS - MIROIRS et LAMPES

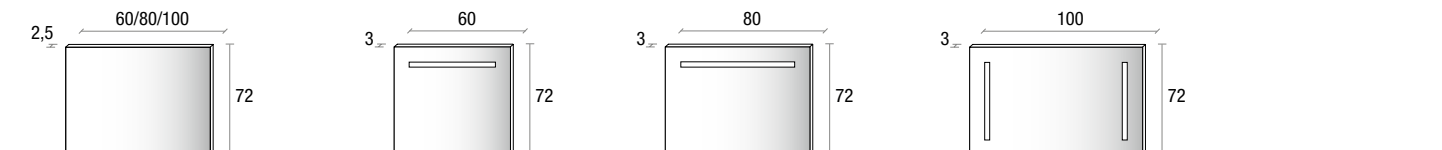

60 cm S005010  
 80 cm S005020  
 100 cm S005030

S381310  
 230 V  
 1 x 8 W  
 IP21 C €

S381350  
 230 V  
 1 x 13 W  
 IP21 C €

S381360  
 230 V  
 2 x 13 W  
 IP21 C €

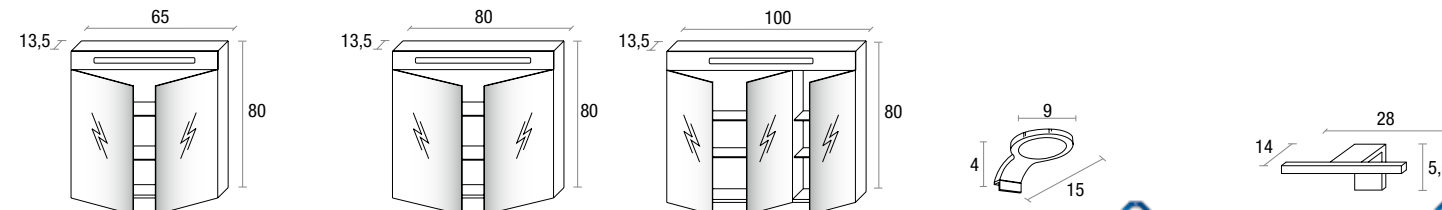

S571010 LG  
 S571010 LC  
 S571010 LL  
 220/240 V - 1 x 24 W - IP44 C €

S571020 LG  
 S571020 LC  
 S571020 LL  
 220/240 V - 1 x 24 W - IP44 C €

S571030 LG  
 S571030 LC  
 S571030 LL  
 220/240 V - 1 x 39 W - IP44 C €

V501140  
 LED  
 220/240 V - 50/60 Hz - 6W  
 IP44 C €

V502010  
 LED  
 220/240 V - 50/60 Hz - 10W  
 IP44 C €

## FINITURE - FINISHES - ACABADOS - FINITIONS

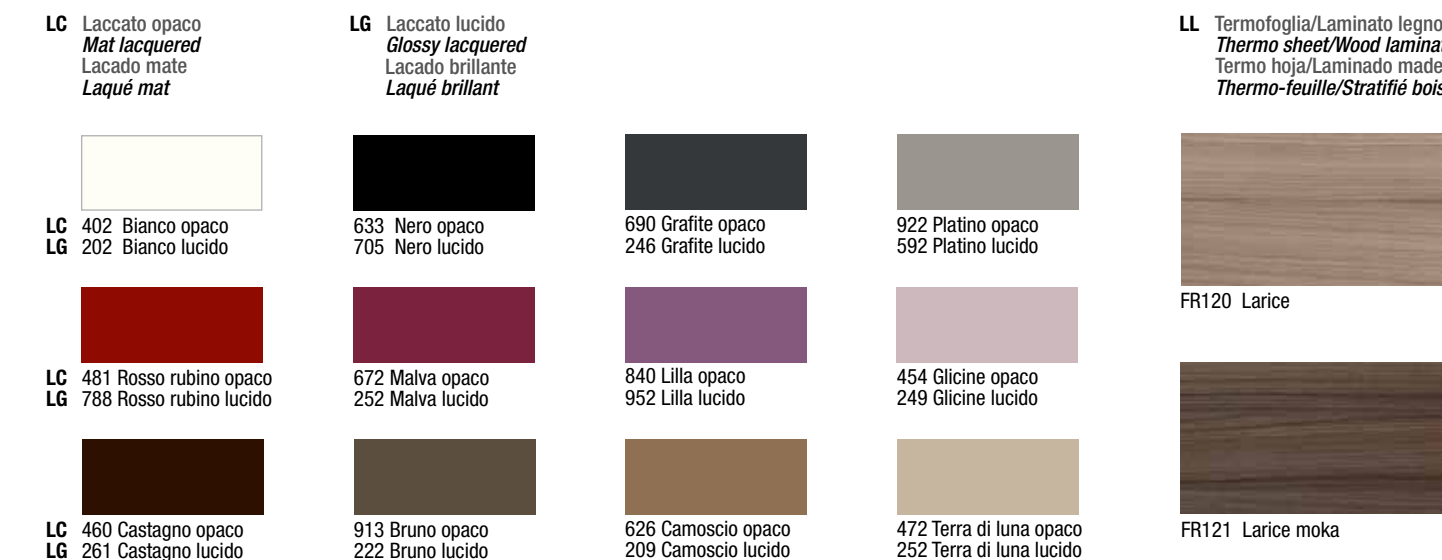

LC Laccato opaco  
*Mat lacquered*  
 Lacado mate  
*Laqué mat*

LG Laccato lucido  
*Glossy lacquered*  
 Lacado brillante  
*Laqué brillant*

LL Termofoglia/Laminato legno  
*Thermo sheet/Wood laminated*  
 Termo hoja/Laminado madera  
*Thermo-feuille/Stratifié bois*

LC 402 Bianco opaco  
 LG 202 Bianco lucido

633 Nero opaco  
 705 Nero lucido

690 Grafite opaco  
 246 Grafite lucido

922 Platino opaco  
 592 Platino lucido

FR120 Larice

LC 481 Rosso rubino opaco  
 LG 788 Rosso rubino lucido

672 Malva opaco  
 252 Malva lucido

840 Lilla opaco  
 952 Lilla lucido

454 Glicine opaco  
 249 Glicine lucido

FR121 Larice moka

LC 460 Castagno opaco  
 LG 261 Castagno lucido

913 Bruno opaco  
 222 Bruno lucido

626 Camoscio opaco  
 209 Camoscio lucido

472 Terra di luna opaco  
 252 Terra di luna lucido

La fedeltà cromatica dei campioni può discostarsi dalla realtà: la cartella colori ha un valore indicativo  
*The chromatic accuracy of the samples can diverge from the reality: the color chart has an approximate value*  
 La reproducción cromática de las muestras puede variar de la realidad: la carta de colores es indicativa  
*La fidélité des couleurs des échantillons peut être différente de la réalité: le nuancier wa une valeur indicative*