

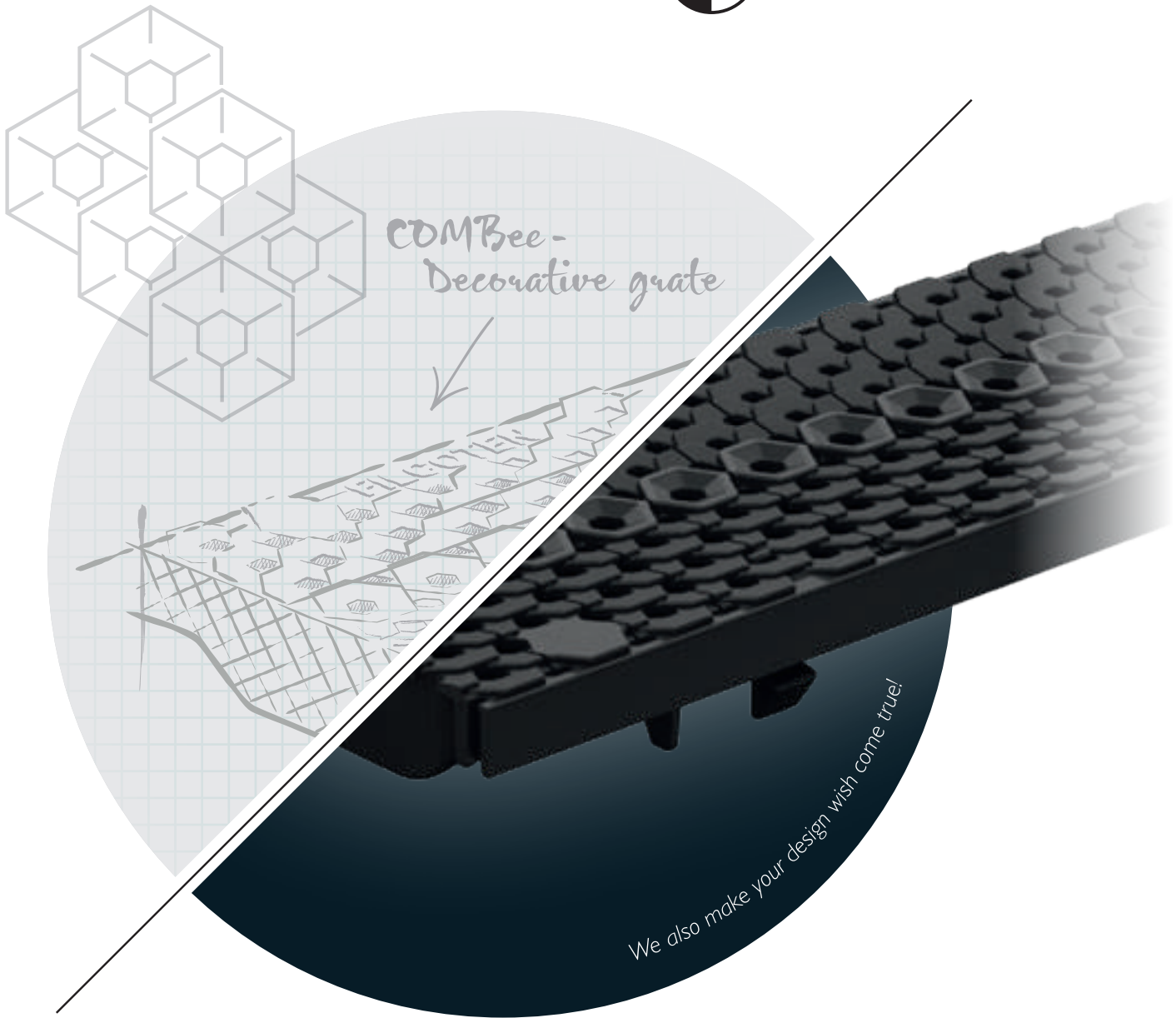

GRASPOINTNER  
Sustainable innovation.



---

# The Art of Drainage

Deco Grate Systems

---

BG-BLACKLABEL  
deco line



[linkedin.com/company/  
bg-graspontner](https://www.linkedin.com/company/bg-graspontner)



[blog.bg-company.com](http://blog.bg-company.com)

**Always up to date – with  
the BG-Blog and LinkedIn.**

Just visit then BG-[Blog](#) and  
link up with us on [LinkedIn](#)



Functionality is good...  
**Functionality  
and superior  
design is better.**



Functionality is important when using products in highly visible, public areas – but design is equally important.

**An array of designs for every need.**

BG-BLACKLABEL is our comprehensive range of high-quality decorative grates for trench drains. Our products can meet the highest aesthetic standards AND do the hard work.

Welcome to the world of BG-BLACKLABEL...

Yours

A handwritten signature in black ink, appearing to read 'Ferdinando Lezza'. The signature is fluid and stylized, with a long horizontal stroke at the end.

Ferdinando Lezza

# Rounded contours, exceptional design.

## VILLE



»» *The geometric form of the circle was my inspiration for the design of VILLE. It represents uniqueness and perfection.* ««

Ulrich Groth | BG-Graspointner

The intricate contours of the VILLE designer grate immediately catch the eye – a harmonious circular pattern that is at once geometric and organic.

Made of high-quality EN GJS 500-7 ductile cast iron, the grate is extremely robust and durable, and suitable for all FILCOTEN® systems.  
The perfect union of purpose and design.

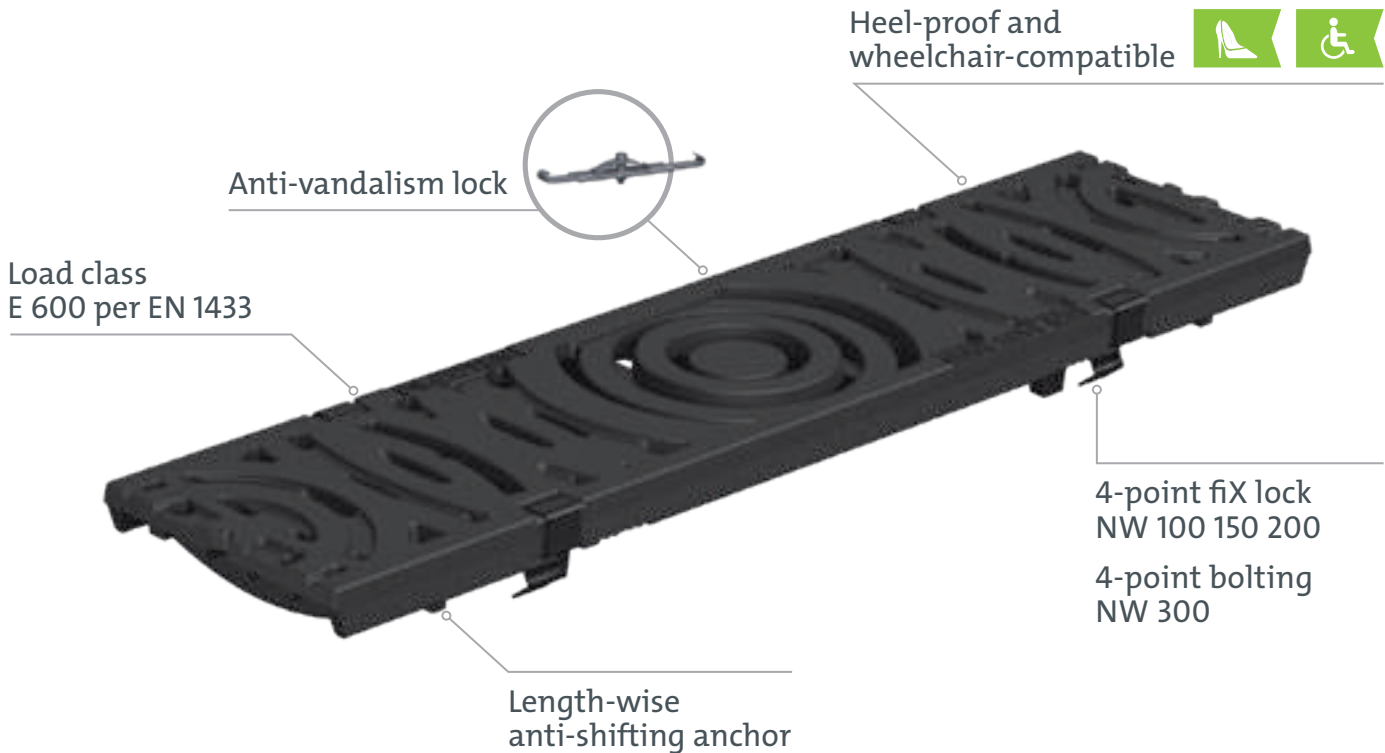

VILLE NW 100



VILLE NW 150



VILLE NW 200



VILLE NW 300

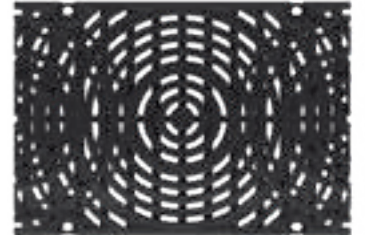

Design: Created by BG-Graspointner

## VILLE Decorative ductile cast iron grate

Nominal width 100 / 150 / 200 / 300, class E600 kN per EN 1433

Item no.	Product	Locking system	Size inch	mm	Slot width inch	mm
17010180	VILLE decorative cast iron grate NW100	4-point fiX lock	19.68" / 4.8" / 0.79"	500 / 122 / 20	0.27"	7
17015180	VILLE decorative cast iron grate NW150	4-point fiX lock	19.68" / 6.77" / 0.79"	500 / 172 / 20	0.27"	7
17020180	VILLE decorative cast iron grate NW200	4-point fiX lock	19.68" / 8.74" / 0.79"	500 / 222 / 20	0.27"	7
17030180	VILLE decorative cast iron grate NW300	4-point bolting	19.68" / 13.66" / 0.98"	500 / 347 / 25	0.27"	7

Please inquire for delivery time

# Flowing shapes, drainage perfection.

## RIVER

» *For me, the beauty of nature is quintessentially revealed in the harmonious flowing movements of a river. A thought has taken form in reality in this grate.*

«

Manuel Knoblechner | BG-Graspointner



The sense of movement is introduced through a flowing design in the RIVER grating. Contours lend both playfulness and symmetry, while maintaining effective, economical function.

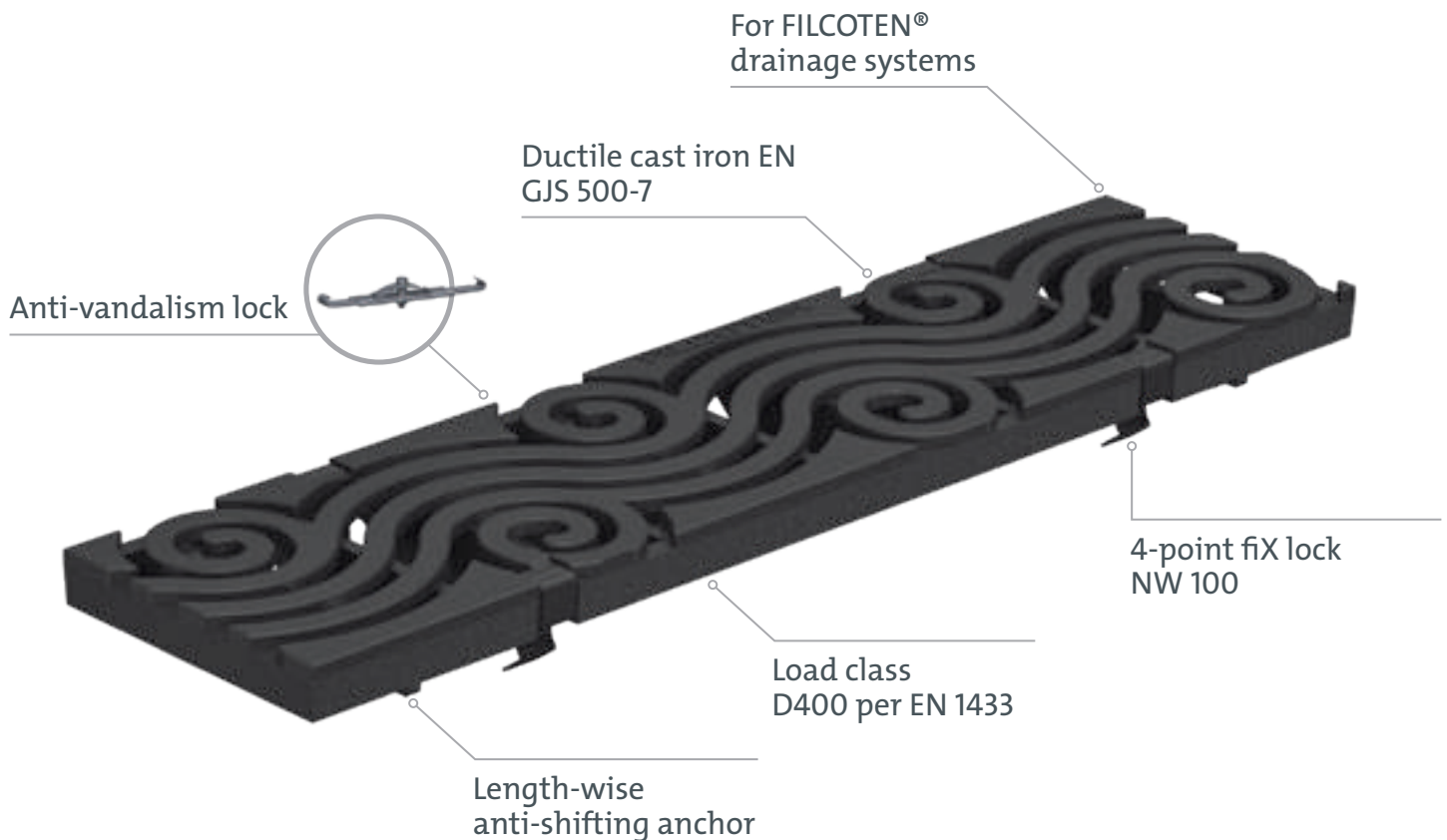



## RIVER Decorative ductile cast iron grate

Nominal width 100, class D400 kN per EN 1433

Item no.	Product	Locking system	Size inch	mm	Slot width inch	mm
	RIVER decorative cast iron grate NW100	4-point fiX lock	19.68" / 4.8" / 0.79"	500 / 122 / 20	0.31"	8

Please inquire for delivery time

# Gets more and more beautiful with age.

## CORTEN STEEL



» *Materials can be dynamic and flexible – corten steel with its natural patina is a prime example.*



Marcus Renn | BG-Graspointner

What materials can stand the test of time? CORTEN STEEL: A special steel that develops an attractive orange-red protective patina when exposed to the elements. The patina creates a striking finish while protecting from rust perforation.

### Laser-precision cutting of your individual design.

There are no limits on creativity with this distinctive material. Tell us the design you have envisioned, and we will laser-cut your grate with precision. These grates are as unique as their designers.

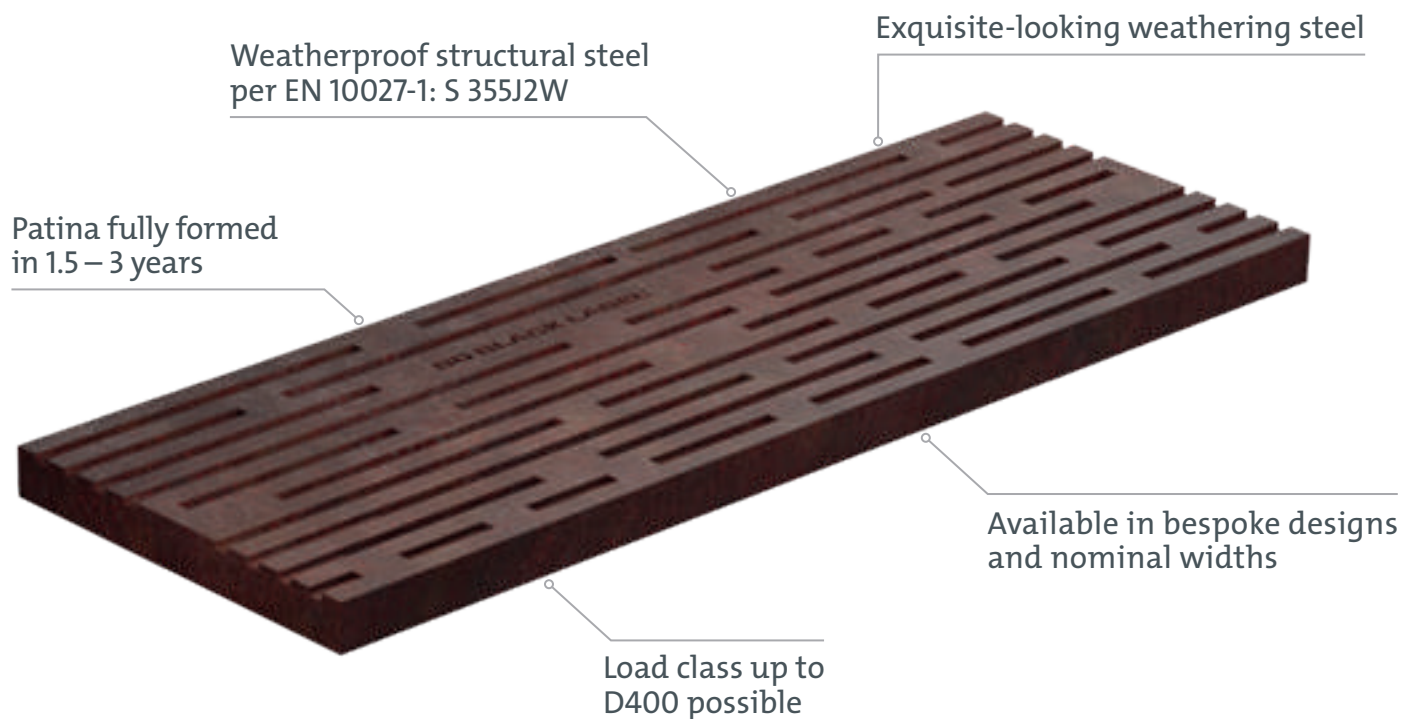



CORTEN STEEL RALLEY



CORTEN STEEL ROUTE

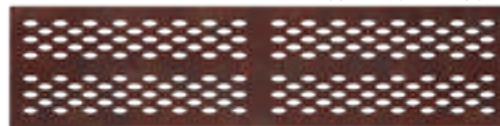

CORTEN STEEL LINEAR



Design: Created by BG-Graspointner

# The road to tasteful design.

## KIARO

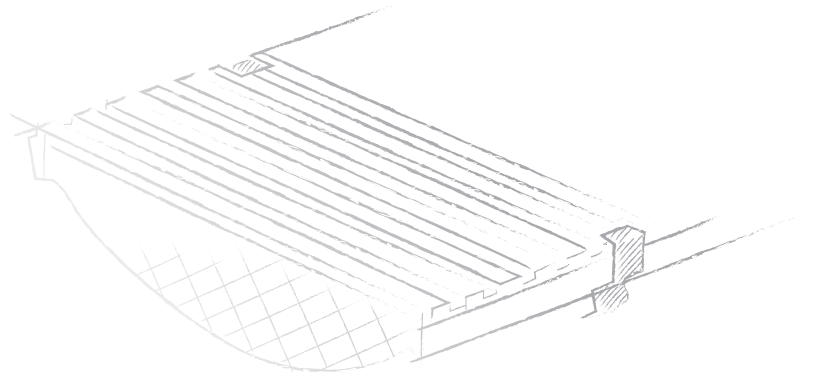

Crisp, straight lines define the look of this designer grate. With its smooth surface, this high-quality model works well in simple, elegant settings.

Don't let its good looks deceive you. KIARO is made of high-grade EN GJS 500-7 ductile cast iron. Here, function meets design, including several practical features.

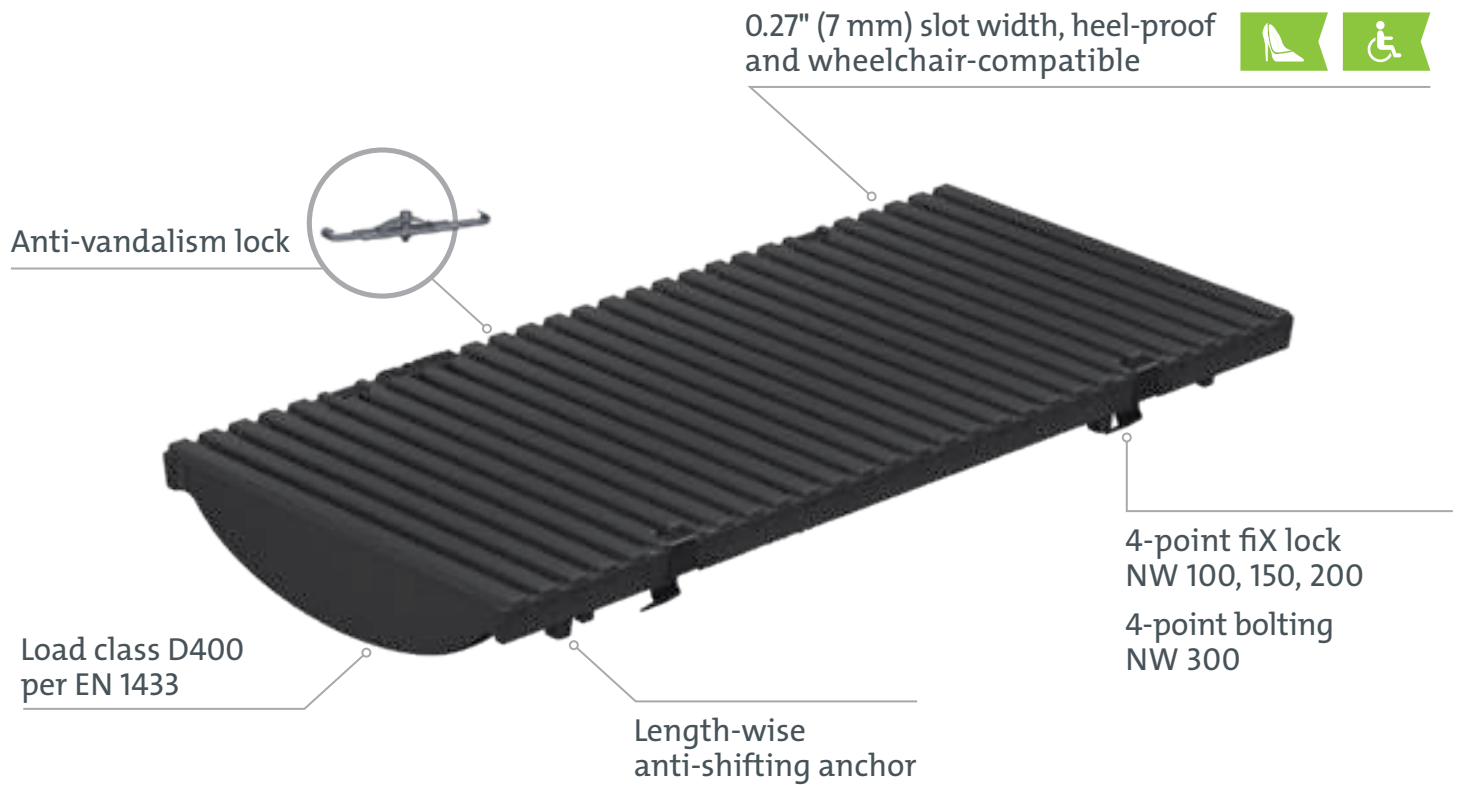

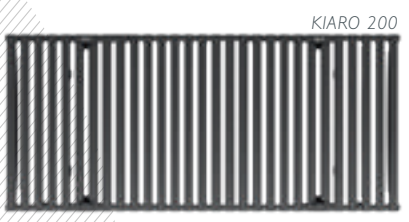
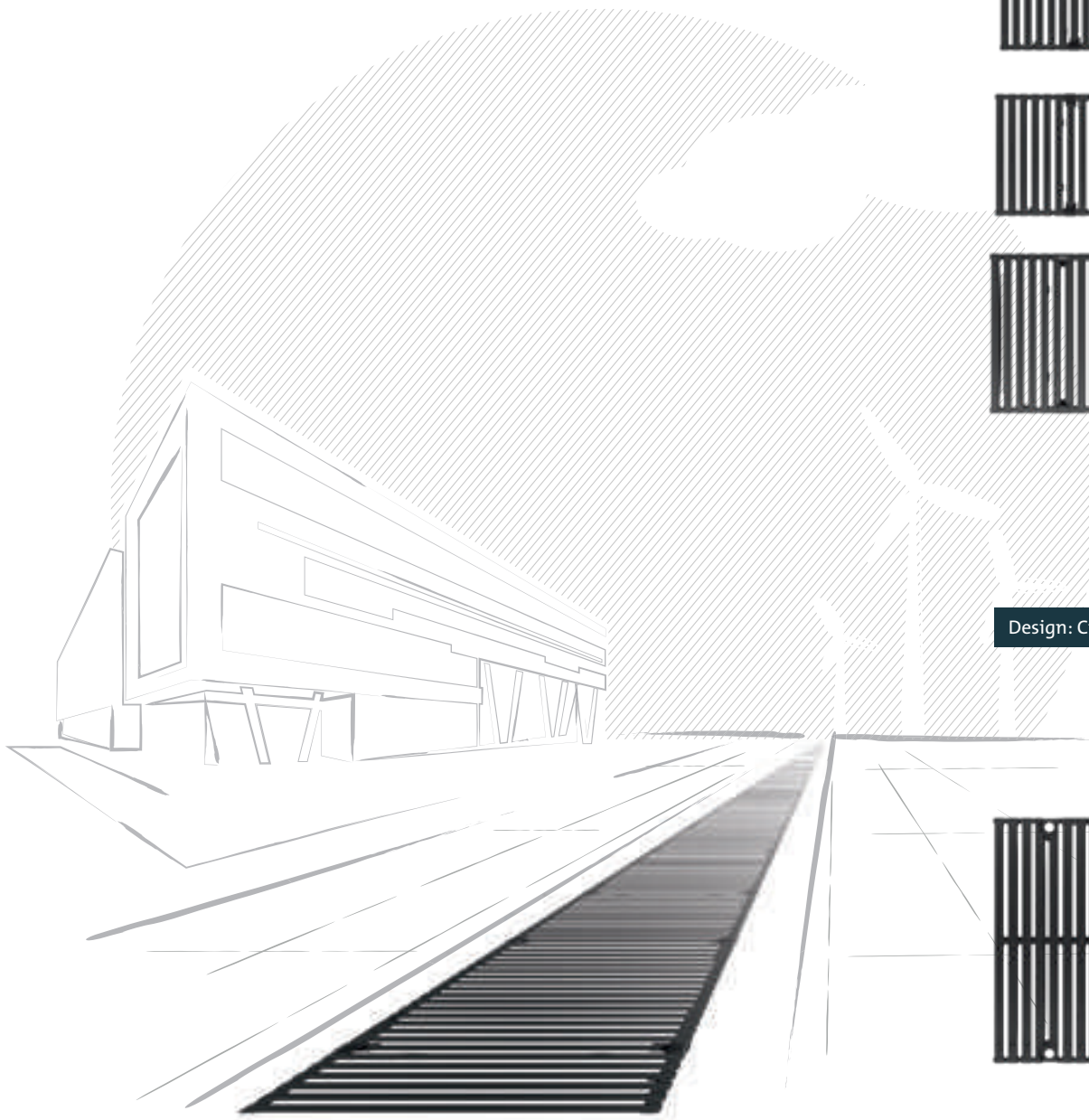

Design: Created by BG-Graspointner

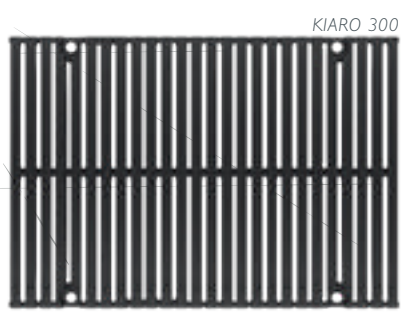

## KIARO Decorative ductile cast iron grate

Nominal width 100 / 150 / 200 / 300, class D400 kN per EN 1433

Item no.	Product	Locking system	Size inch	mm	Slot width inch	mm
17010183	KIARO decorative cast iron grate NW100	4-point fiX lock	19.68" / 4.8" / 0.79"	500 / 122 / 20	0.27"	7
17015183	KIARO decorative cast iron grate NW150	4-point fiX lock	19.68" / 6.77" / 0.79"	500 / 172 / 20	0.27"	7
17020183	KIARO decorative cast iron grate NW200	4-point fiX lock	19.68" / 8.74" / 0.79"	500 / 222 / 20	0.27"	7
17030183	KIARO decorative cast iron grate NW300	4-point bolting	19.68" / 13.66" / 0.98"	500 / 347 / 25	0.27"	7

Please inquire for delivery time

# The path to stylishness.

## VIA

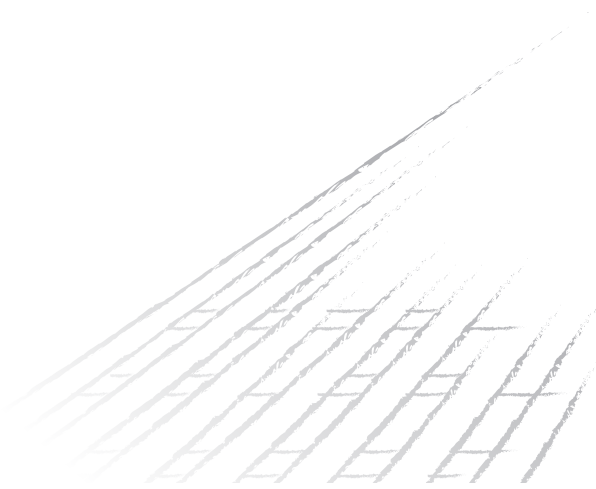

Like the KIARO model, the designer grate VIA has a clean line, and features longitudinal bars suitable for all FILCOTEN® drainage systems. Running length-wise rather than cross-wise, the bars create a path, blending subtly into the environment.

With a smooth surface made of EN GJS 500-7 ductile cast iron, this attractive, robust model has a massive, high-quality look.

0.27" (7 mm) slot width, heel-proof  
and wheelchair-compatible



Anti-vandalism lock



Load class D400  
per EN 1433

Length-wise  
anti-shifting anchor

4-point fix lock  
NW 100, 150, 200

4-point bolting  
NW 300



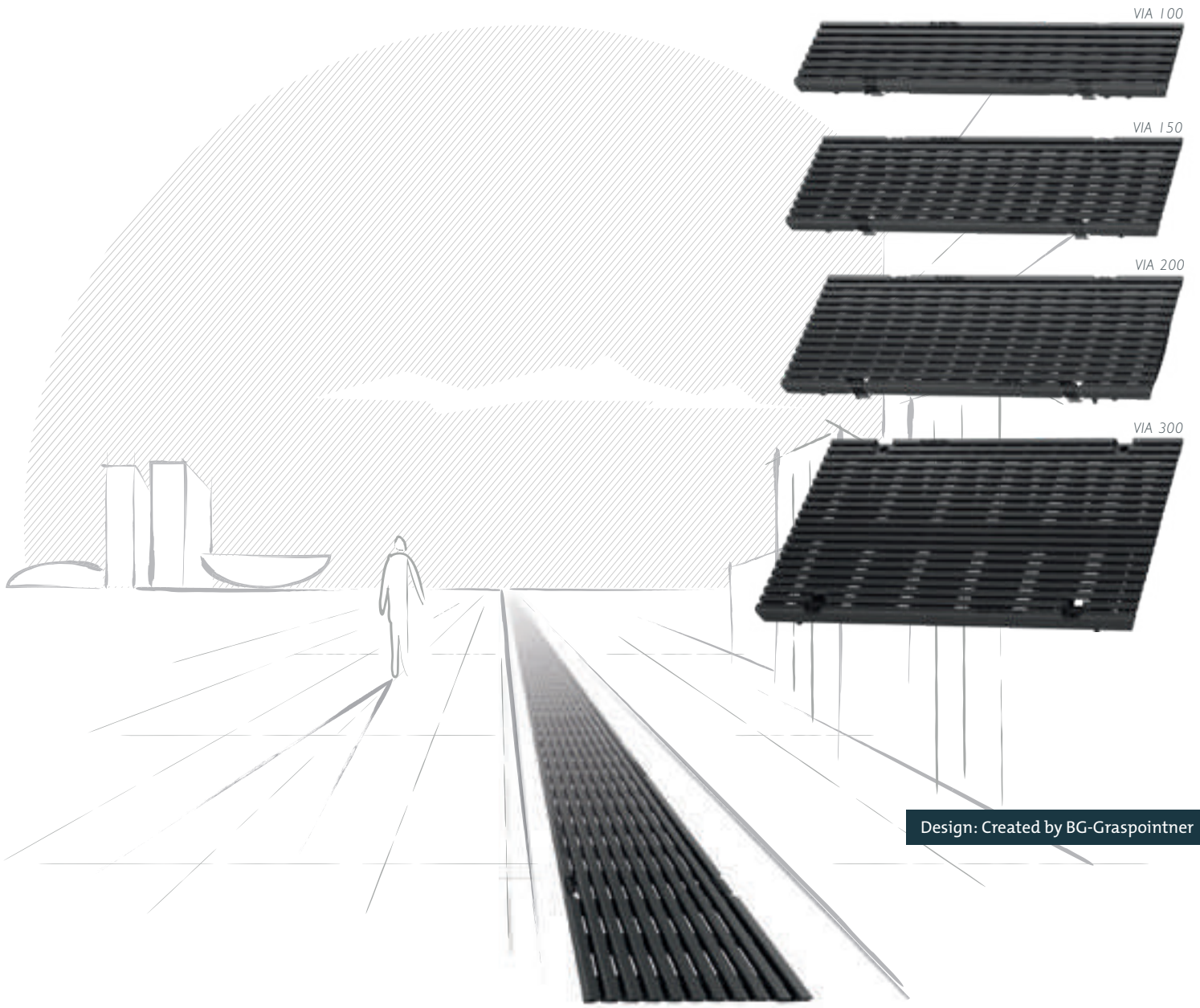

## VIA Decorative ductile cast iron grate

Nominal width 100 / 150 / 200 / 300, class D400 kN per EN 1433

Item no.	Product	Locking system	Size inch	mm	Slot width inch	mm
17010184	VIA decorative cast iron grate NW100	4-point fiX lock	19.68" / 4.8" / 0.79"	500 / 122 / 20	0.27"	7
17015184	VIA decorative cast iron grate NW150	4-point fiX lock	19.68" / 6.77" / 0.79"	500 / 172 / 20	0.27"	7
17020184	VIA decorative cast iron grate NW200	4-point fiX lock	19.68" / 8.74" / 0.79"	500 / 222 / 20	0.27"	7
17030184	VIA decorative cast iron grate NW300	4-point bolting	19.68" / 13.66" / 0.98"	500 / 347 / 25	0.27"	7

*Please inquire for delivery time*

# Inspired by the glory of nature.

## COMBEE



» *Sometimes the small things are the most important. In design, greatness lies in the detail. This has to do with my inspiration to give this grate a honeycomb pattern.* «

Steffen Bernauer | BG-Graspointner



This eye-catching honeycomb design will raise the style level of any setting. Part of the BLACKLABEL line, and synonymous with technological excellence, the COMBEE is made of PA6 polyamide.

This semi-crystalline thermoplastic is extremely stable, with good damping and wear characteristics, and is highly resistant to many oils, greases and fuels.

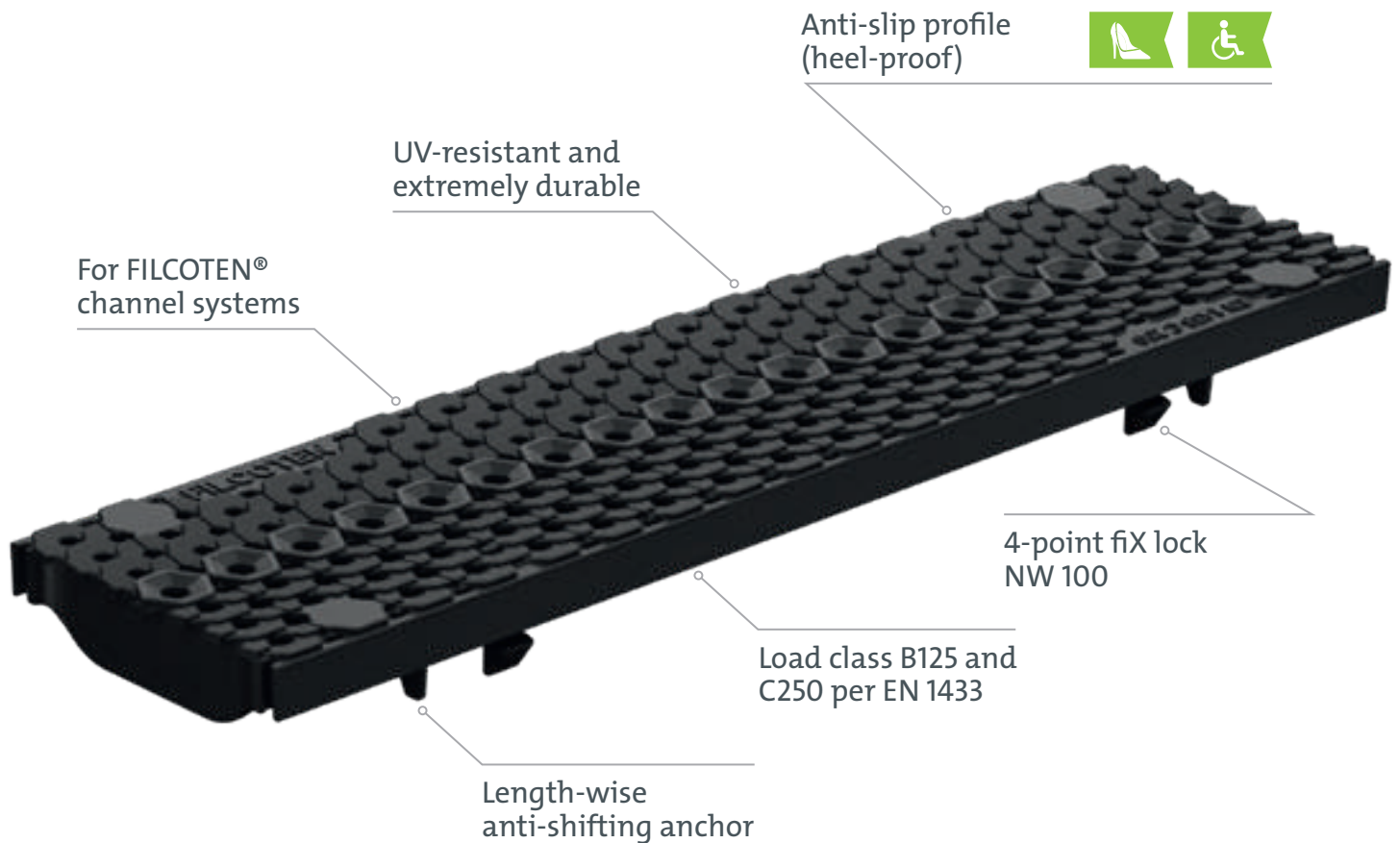

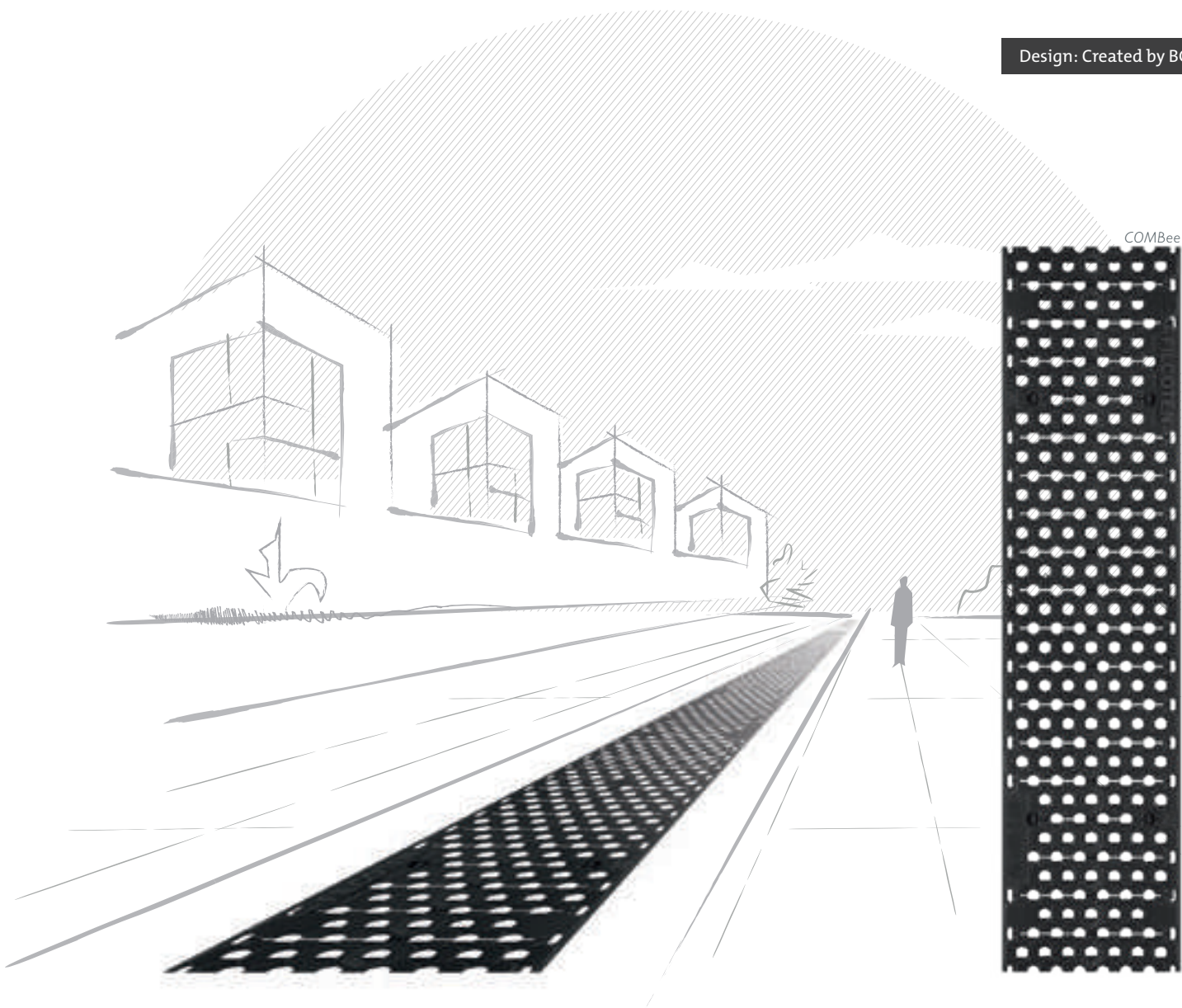

## COMBEE Decorative composite grate

Nominal width 100, class B125 kN and C250 kN per EN 1433

Item no.	Product	Locking system	Size inch	mm	Slot width inch	mm
17010401	COMBEE decorative grate NW100, cl. B	4-point fiX lock	19.68" / 4.8" / 0.79"	500 / 122 / 20	ø 0.27"	ø 7
17010402	COMBEE decorative grate NW100, cl. C	4-point fiX lock	19.68" / 4.8" / 0.79"	500 / 122 / 20	ø 0.27"	ø 7

Please inquire for delivery time

# Design as an expression of your personality.

## BLACKLABEL INDIVIDUAL

With BLACKLABEL INDIVIDUAL you can unleash your creativity. Design your own unique grate and leave the manufacturing to us. Our team will work closely with you to ensure that your vision becomes reality.

### Making your individual designer grate.

- **Design phase**

Using sketches and drawings, you design the grate.



- **Planning and advice**

Contact us to arrange a consultation.



- **Implementation**

A technician makes a 3D design model based on your sketches.



- **Feedback**

You review the 3D model of your grate and provide feedback.



- **Production**

After any adjustments are made based on your feedback, the grate goes into production in the desired quantity.

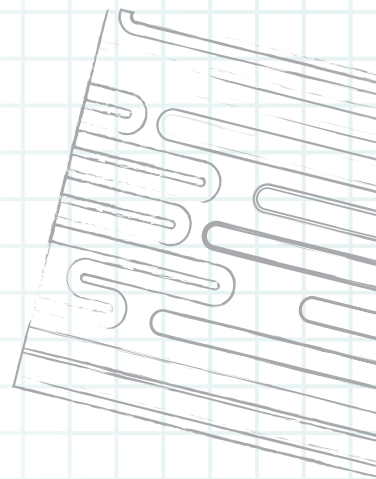



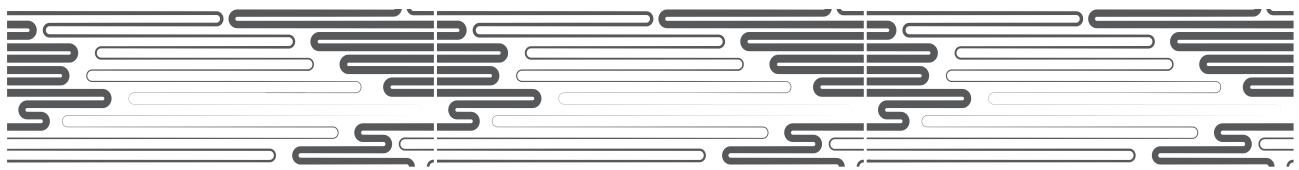
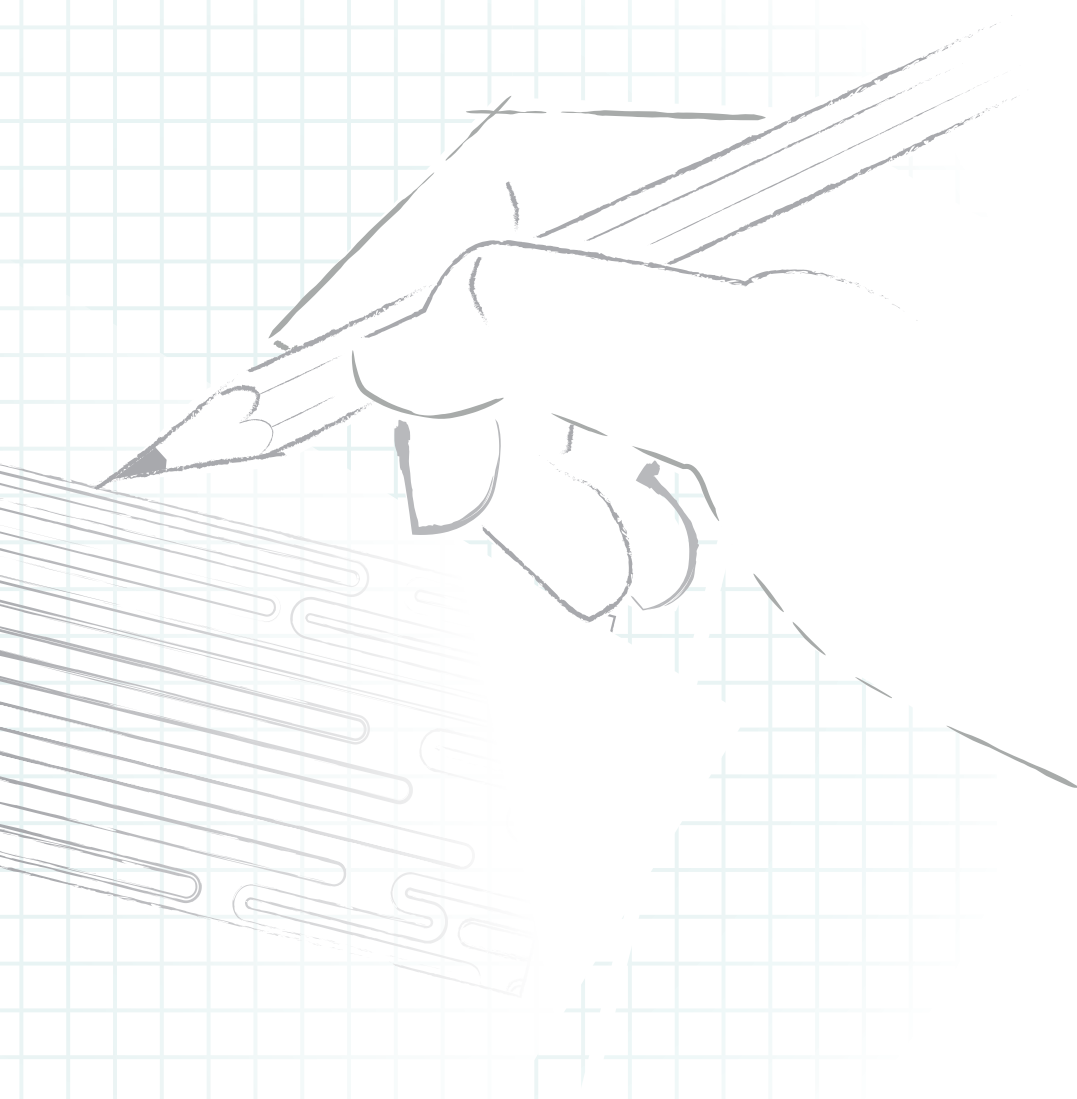

# Elegance all down the line.

## PIAZZA

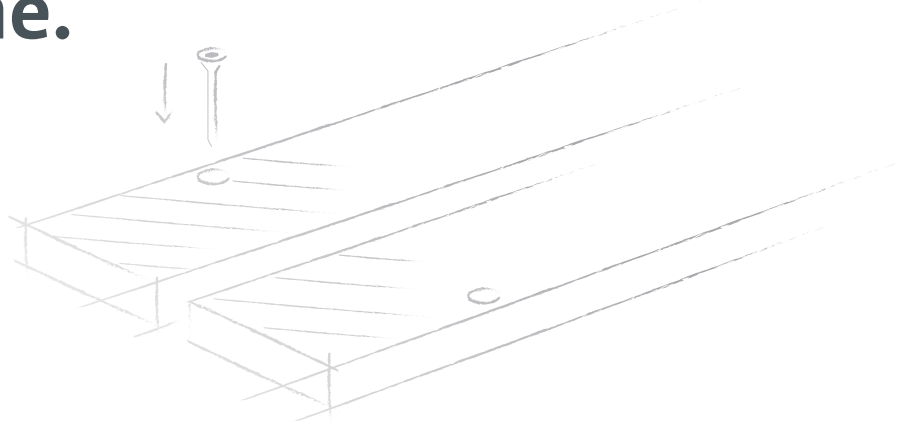

Elegance is often associated with a minimalist approach.

This attractive slotted grate blends seamlessly into any environment, while maintaining a hard-working function.

This massive, nearly closed slotted grate makes a bold impression as a design element, highlighting its top-quality production material.

Made of EN GJS 500-7 ductile cast iron, it is durable, stable, extremely efficient and suitable for all FILCOTEN® drainage systems.

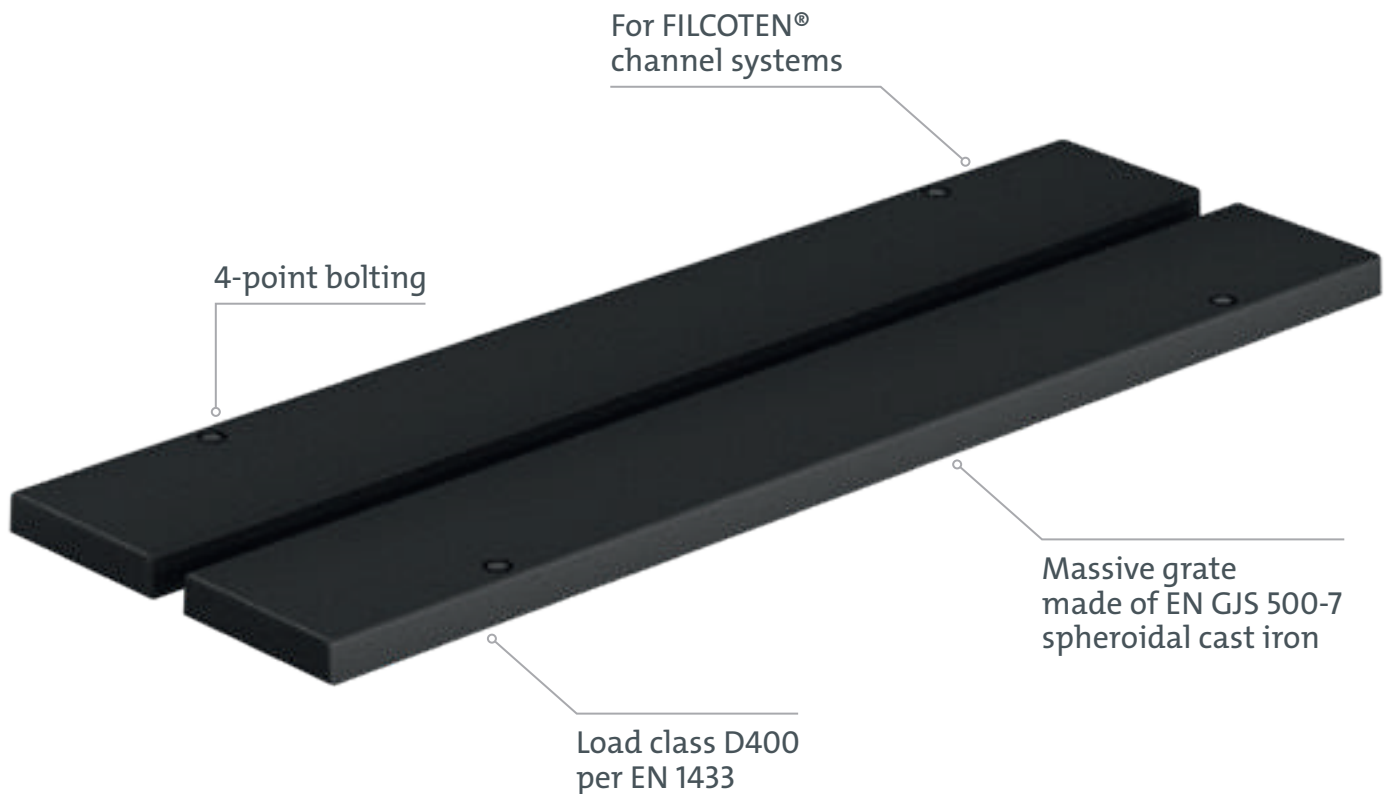

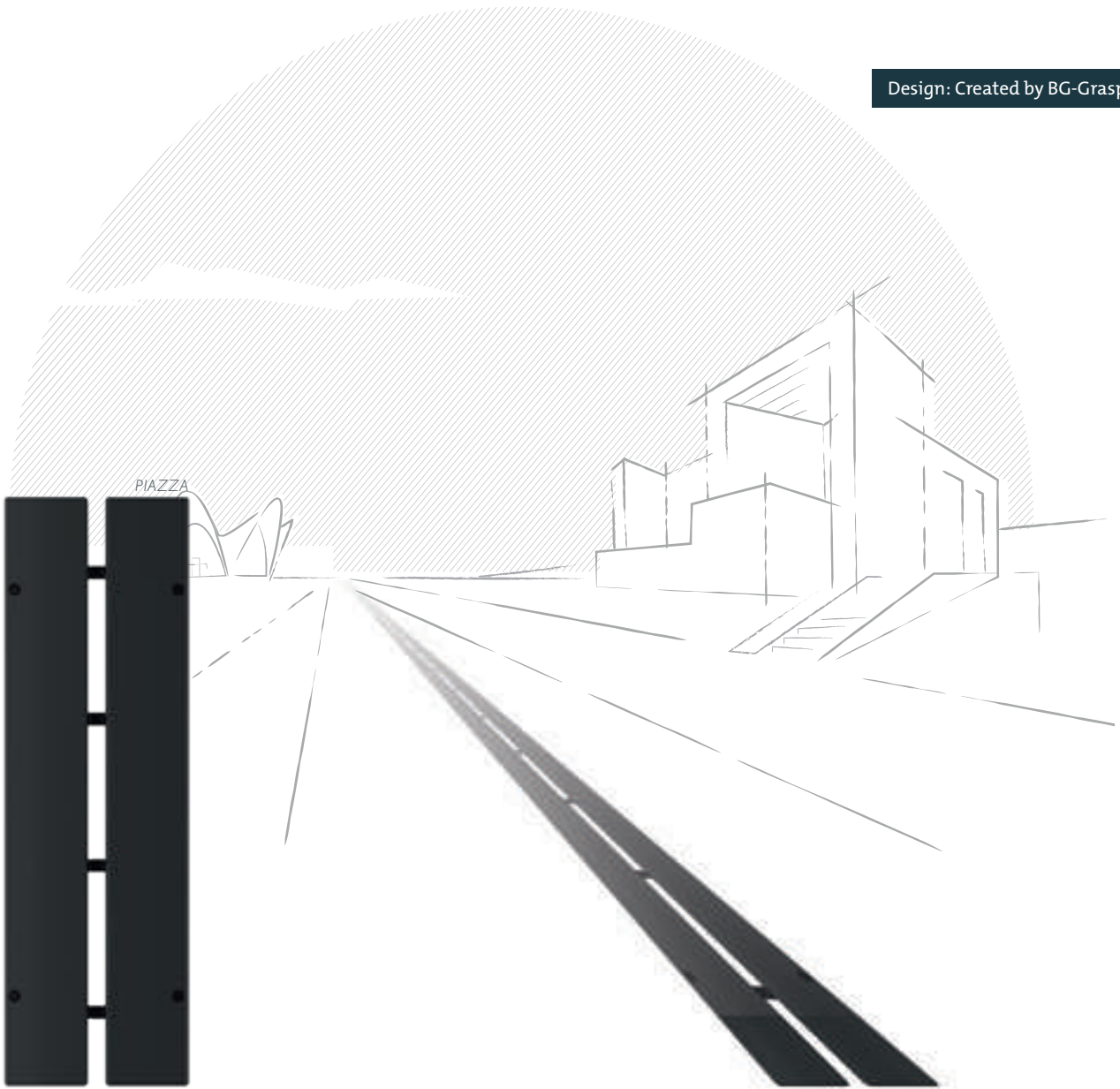

## PIAZZA Decorative ductile cast iron gate

Nominal width 100, class D400 kN per EN 1433

Item no.	Product	Locking system	Size inch	mm	Slot width inch	mm
	PIAZZA decorative cast iron grate NW100	4-point bolting	19.68" / 4.8" / 0.79"	500 / 122 / 20	0.59"	15

*Please inquire for delivery time*

# Because good design is unobtrusive.

## SLOT TOP 2S HEEL-PROOF

High quality meets subtle design. The slot top solutions made of stainless or galvanized steel have a lasting impression. Performance matches looks in this elegant, robust grating.

The high-quality slot top offers technical refinement, with a heel-proof dual-slot design and delivers excellent drainage performance.

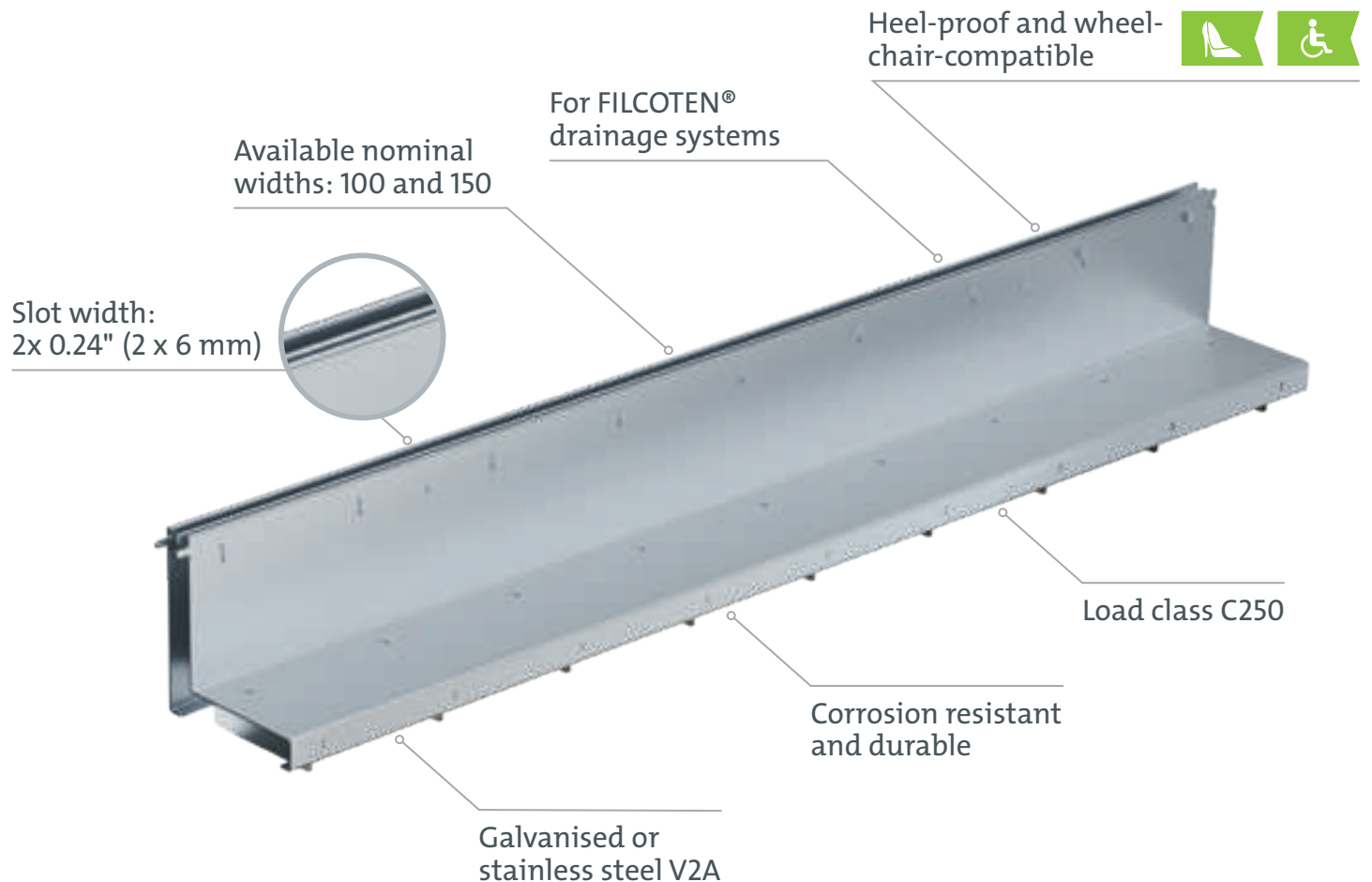
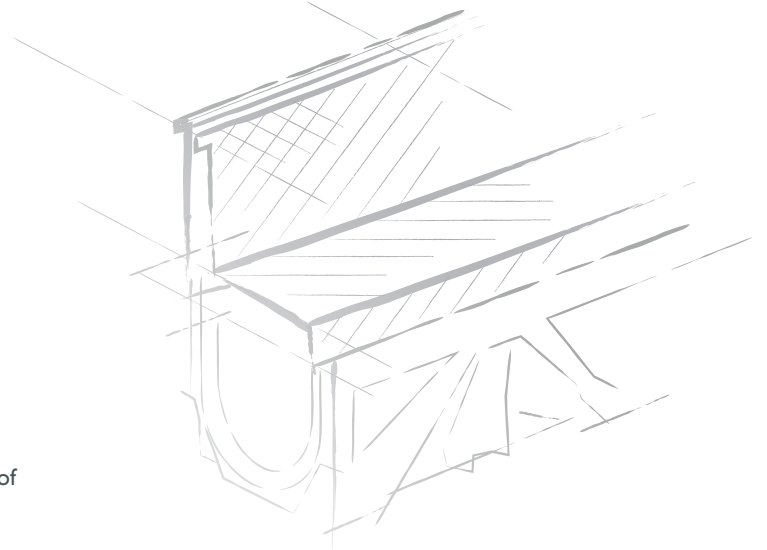

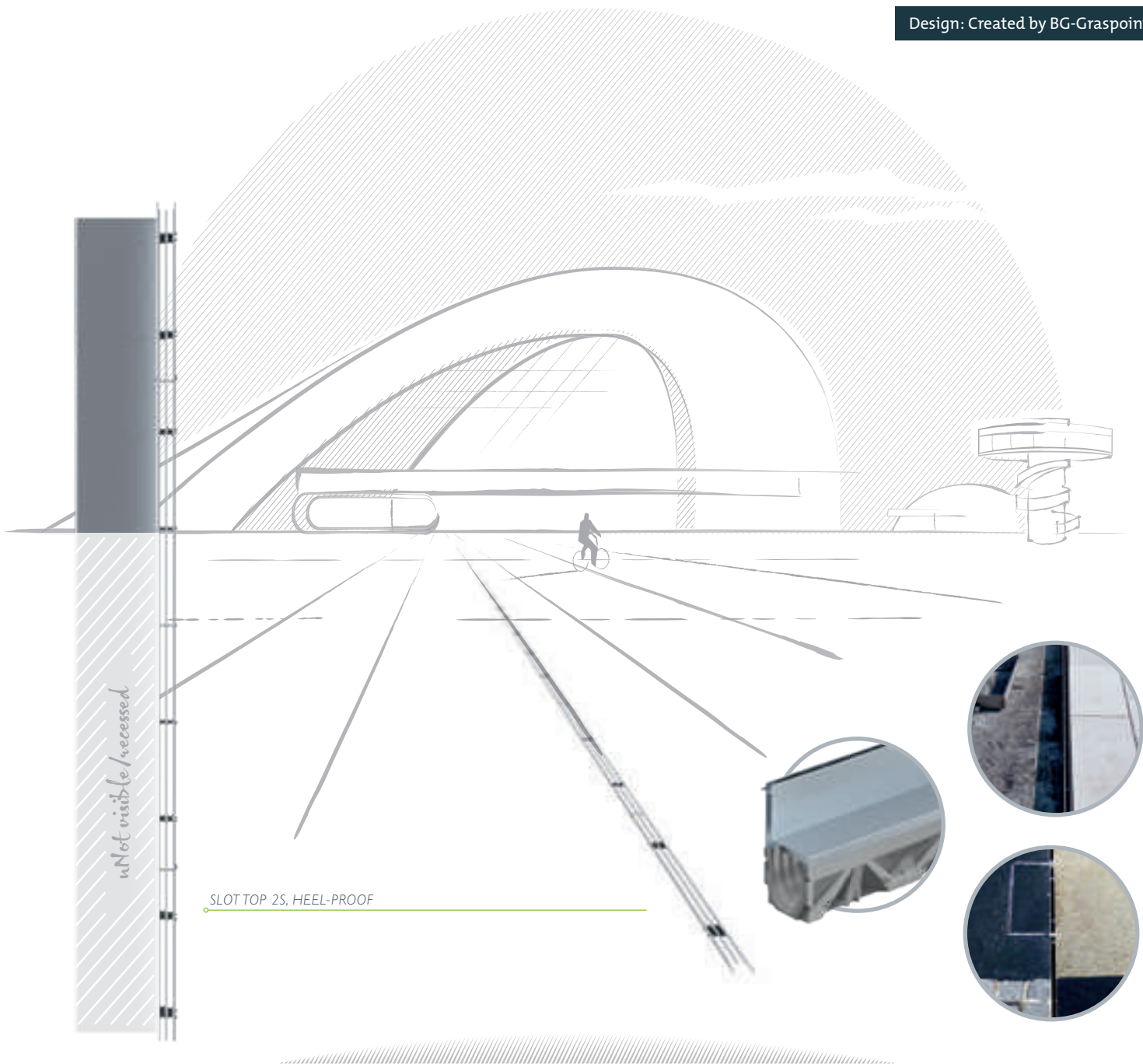

## SLOT TOP 2S, HEEL-PROOF

Nominal width 100 / 150, class C250 kN per EN 1433

Item no.	Product	Material	Size inch   mm	Slot width inch   mm
17111204	SLOT TOP 2S, HEEL-PROOF NW100	Galvanised	39.37" / 4.8" / 5.23", SH 4.33"	1000 / 123 / 133, SH110   2x 0.24"   2x 6
17111205	SLOT TOP 2S, HEEL-PROOF NW100	Galvanised	19.68" / 4.8" / 5.23", SH 4.33"	500 / 123 / 133, SH110   2x 0.24"   2x 6
17111304	SLOT TOP 2S, HEEL-PROOF NW100	Stainless steel V2A	39.37" / 4.8" / 5.23", SH 4.33"	1000 / 123 / 133, SH110   2x 0.24"   2x 6
17111305	SLOT TOP 2S, HEEL-PROOF NW100	Stainless steel V2A	19.68" / 4.8" / 5.23", SH 4.33"	500 / 123 / 133, SH110   2x 0.24"   2x 6
17116204	SLOT TOP 2S, HEEL-PROOF NW150	Galvanised	39.37" / 7.09" / 5.23", SH 4.33"	1000 / 180 / 133, SH110   2x 0.24"   2x 6
17116205	SLOT TOP 2S, HEEL-PROOF NW150	Galvanised	19.68" / 7.09" / 5.23", SH 4.33"	500 / 180 / 133, SH110   2x 0.24"   2x 6
17116304	SLOT TOP 2S, HEEL-PROOF NW150	Stainless steel V2A	39.37" / 7.09" / 5.23", SH 4.33"	1000 / 180 / 133, SH110   2x 0.24"   2x 6
17116305	SLOT TOP 2S, HEEL-PROOF NW150	Stainless steel V2A	19.68" / 7.09" / 5.23", SH 4.33"	500 / 180 / 133, SH110   2x 0.24"   2x 6

Please inquire for delivery time

# Detailed planning for an outstanding system

FILCOTEN® HPC is a high-performance concrete that combines outstanding technical properties with eco-sustainability. The optimised, high-density structure of HPC allows manufacturing of lightweight drainage channels that have the same stability and load capacity as conventional concrete systems. FILCOTEN® requires less raw materials and the products are 100% recyclable<sup>1)</sup>, certified pollutant-free<sup>2)</sup>, making FILCOTEN® a unique environmentally friendly product



## FILCOTEN® pro / pro mini

- NW pro 100/150/200/300 with slope no. 0-10
- NW pro 400 BH 490
- NW pro mini BH 60/80/100/120
- Galvanised edge protection, stainless steel, cast iron
- Length 1000/500 mm

## Special element

- Smooth side wall for drilling
- T-pieces & cross-pieces realisable
- NW 100/150/200
- Length 500 mm BH no. 5-0

## Binds easily to the concrete bed

- lateral anchoring pockets for maximum anchorage in the concrete bed
- permanent fit in the foundation thanks to the identical linear expansion coefficient
- perfect connection between HPC and concrete

## Sump unit

- easy maintenance and cleaning of the drainage system
- Sediment bucket included
- Sealed pipe connection
- Length 500 mm



GRASPOINTNER  
Sustainable innovation.

<sup>1)</sup> Quality class UA – certified by the Salzburg Construction Experimentation & Research Institute

<sup>2)</sup> fulfils the strict criteria outlined by the Rosenheim Institute for Construction Biology (IBR)

<sup>3)</sup> No synthetic resins used

**Verified LCA (Life Cycle Assessment)**

- Low greenhouse gas emission levels
- produced using an exclusively green power
- Resource-efficient production process



**FILCOTEN<sup>®</sup> tec**

- NW 100 with slope no. 0-10
- NW 150 BH 190
- NW 200 BH 195
- Galvanised or stainless steel edge protection
- Length 1000/500 mm

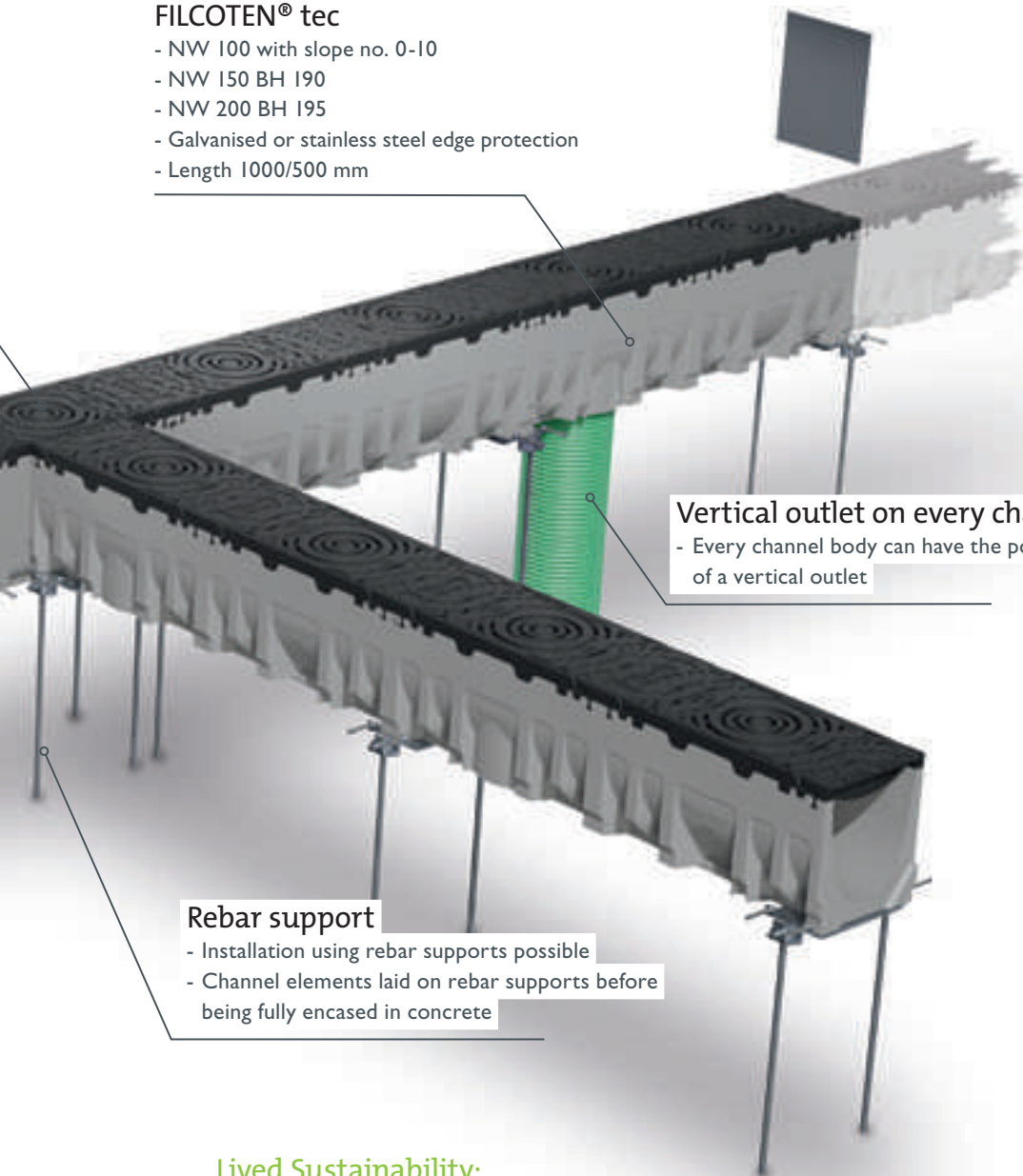

**Vertical outlet on every channel**

- Every channel body can have the possibility of a vertical outlet

**Rebar support**

- Installation using rebar supports possible
- Channel elements laid on rebar supports before being fully encased in concrete

**Lived Sustainability:  
FILCOTEN<sup>®</sup> HPC (High Performance Concrete)**

- Cement-bound mineral material
- Extremely durable, stable and UV-resistant
- extremely resistant to frost, de-icing salt, oil, gasoline
- 100% recyclable certified <sup>1)</sup>
- Certified environmental and energy management certified acc. to ISO 14001 or 50001 at the location in Oberwang, Austria
- Tested by the IBR<sup>2)</sup> – safe in terms of building biology

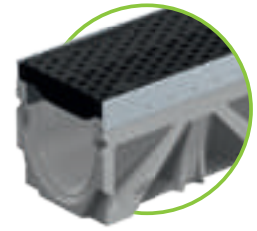

FILCOTEN<sup>®</sup> tec e/v  
Commercial Duty | E600



FILCOTEN<sup>®</sup> pro e/v  
Heavy Duty | E600



FILCOTEN<sup>®</sup> pro mini e/v  
Heavy Duty | E600



FILCOTEN<sup>®</sup> pro g  
Extra Heavy Duty | F900



# Because a thing of beauty should last. **MATERIALS USED**

BLACKLABEL designer grates use only high-quality materials. These products are exceptionally robust, durable and high-quality. The superiority is recognizable, as is the outstanding design.

## CAST IRON

We use high-quality, graphite-rich ductile iron, also known as spheroidal or nodular cast iron to manufacture our grates and covers. The specific properties of EN GJS 500-7 make it the ideal material for cast iron grates.

## CORTEN STEEL

Corten steel (Cor-Ten or weathering steel) is a special kind of steel that naturally develops an attractive orange-red protective coating or “patina” over time. The patina protects steel from rust perforation, making it a superb material for crafting interesting, designer elements like our channel cover. Corten steel covers per EN 10027-1: S 355J2W are precision-cut and refined by laser.

## POLYAMIDE PLASTIC

Our COMBee grate is made of polyamide plastic – a semi-crystalline thermoplastic that has balanced mechanical properties. Polyamide is durable, has good damping and wear properties and is resistant to many oils, greases and fuels.

## GALVINISED STEEL

We use Z275 galvanised sheet steel for many of our steel products, such as our slotted top attachments. Both sides are hot-dip galvanised to extend the shelf life, and protect the steel against corrosion even in areas where steel surfaces are exposed, such as cut edges.

## STAINLESS STEEL





Nearly all of our steel products are available in 1.4301 stainless steel, often referred to as V2A for short. This is an austenitic, acid-resistant chrome-nickel steel with good polishability and formability for deep drawing, bending and roll-forming. Because of its excellent corrosion and acid-resistance properties, stainless steel is used for a wide variety of applications in the food industry and swimming pools.











There are two main loading class standards in the trench drain industry to help specifiers select the appropriate grate:

**ANSI A112.21.1M** Grates and top rims shall be designed to meet the following loading classifications in a static condition.

- 
**Light Duty** All grates having safe live load (as calculated in paragraph 6.1.6 of the ANSI Standard) under 2,000 lbs. (900 kg.) For pedestrian foot traffic only.
- 
**Medium Duty** All grates having safe live load (as calculated in paragraph 6.1.6 of the ANSI Standard) between 2,000 lbs. (900 kg.) and 4,999 lbs. (2,250 kg.) For light pneumatic tire traffic only. Sidewalks and residential parking.
- 
**Heavy Duty** All grates having safe live load (as calculated in paragraph 6.1.6 of the ANSI Standard) between 5,000 lbs. (2,250 kg.) and 7,499 lbs. (3,375 kg.) For Commercial Pneumatic tire traffic patterns and tractor trailers.
- 
**Extra Heavy Duty** All grates having safe live load (as calculated in paragraph 6.1.6 of the ANSI Standard) between 7,500 lbs. (3,375 kg.) and 10,000 lbs. (4,500 kg.) For forklift traffic. Roads and Highways. H-20 Load Rated.
- 
**Special Duty** All grates having safe live load (as calculated in paragraph 6.1.6 of the ANSI Standard) over 10,000 lbs. (4,500 kg.) For airport traffic.

**DIN 19580/ EN1433** Grates and top rims shall be designed to meet the following loading classifications in a static condition.

- 
**Load Class A** Light Duty Grate design load up to or exceeding 3,372 lbs per foot. (15 kN). For pedestrian foot traffic only.
- 
**Load Class B** Medium Duty Grate design load of at least 28,100 lbs per foot. (125 kN). For light pneumatic tire traffic only. Sidewalks and residential parking.
- 
**Load Class C** Heavy Duty Grate design load of at least 56,200 lbs per foot. (250 kN). Commercial Applications.
- 
**Load Class D** Grate design load of at least 89,920 lbs per foot. (400 kN). For pneumatic forklift traffic. Extra Heavy Duty. Roads and Highways. H-20 Load Rated.
- 
**Load Class E** Grate design load of at least 134,800 lbs per foot. (600 kN). For Commercial Solid tire traffic patterns, and impacts from steel struts or metal wheels (forklifts).
- 
**Load Class F** Grate design load of at least 202,320 lbs per foot. (900 kN). For airport traffic. Requires Engineer designed system, please call for additional information.

### Transportation Classifications

The American Association of State Highway and Transportation Officials' (AASHTO) "Standard Specification for Highway Bridges" defines H-20 loading as a two-axle truck with a maximum dual-wheel load of 16,000 lbs. HS-20 loading is defined as a tractor truck with a tandem axle semi-trailer with a dual-wheel load of 16,000 lbs.

The FAA (Federal Aviation Administration) Advisory Circular AC 150/5320-6D describes aircraft loading as 100,000 lbs. placed over a 9" x 9" area. The Americans with Disabilities Act (ADA) stipulates that the slot width be limited on gratings in walkways and elongated slots must be placed longitudinally so that they are perpendicular to the dominant direction of travel.

Heel-proof is defined as slots or perforations that are less than ¼" in width or diameter.

# Knowledge is power – especially with such fine products...

## ADDITIONAL BROCHURES AND CATALOGUES.

All brochures and catalogues are available for download on our website. A convenient way to find out about our entire product range.

 [bg-company.com/bg\\_brochures.html](http://bg-company.com/bg_brochures.html)



### FILCOTEN® one

Get more information about our new FILCOTEN® one – The monolithic drainage system.



### FILCOTEN® pro g extra heavy duty series

Our new BG product catalogue about FILCOTEN® pro g – especially for USA and Canada.



### BG Product Catalogue 2018

Our product brochure 2018.



### FILCOTEN® parkline

Read more about our new drainage system especially for park garages.



### FILCOTEN® pro e and pro v heavy duty series

Our new BG product catalogue about FILCOTEN® pro e and pro v – especially for USA and Canada.







GRASPOINTNER  
Sustainable innovation.

Hydro BG Inc. North America  
642 De Courcelle, suite 206  
Montreal (QC), H4C 3C5  
CANADA

Phone: +1 514 932 5445  
Fax: +1 514 932 5775  
E-Mail: [sales@hydrobg.com](mailto:sales@hydrobg.com)  
Web: [www.hydrobg.com](http://www.hydrobg.com)

Hydro BG Inc. USA  
134 Boynton Ave  
Plattsburgh, NY 12901  
USA

Phone: +1 518 299 1500  
Fax: +1 518 536 9007  
E-Mail: [sales@hydrobg.com](mailto:sales@hydrobg.com)  
Web: [www.hydrobg.com](http://www.hydrobg.com)

Your partner for BG-Graspointner drainage systems

