



cisal

VITA
Collection

design by Karim Rashid

Karim



cisal



«La bellezza del luogo ci illude, e a momenti ci fa credere che il tempo si sia fermato»

Orta mia. Mario Soldati 1960

“The beauty of this place deceives us, and at times makes us believe that time stands still”

Orta mia. Mario Soldati 1960



CHI SIAMO

CISAL rappresenta un esempio di industria italiana autonoma ed integrata, a ciclo di produzione completo, caratterizzato da soluzioni tecnologiche e gestionali innovative. Cisol è oggi uno dei protagonisti dell'innovazione nel settore, con grande sensibilità per l'efficiente uso delle risorse, in primis acqua ed energia, e costante attenzione allo sviluppo continuo di prodotti innovativi nel design, nei materiali, nel funzionamento e nelle prestazioni. Le Collezioni combinano sapientemente estetica, funzionalità e affidabilità, grazie alla collaborazione con designers internazionali quali Karim Rashid, Giampiero Peia, Fabio Rotella, the Collections masterfully combine aesthetics, functionality and reliability.

ABOUT US

Cisal is the outstanding example of an independent and fully integrated Italian manufacturer, performing the complete production cycle, characterised by innovative technology and management solutions.

Cisal is now one of the leading innovators in the industry and is very conscience about the efficient use of resources, water and energy, and focuses on the continuous development of innovative products with regard to design, materials, function and performance. Thanks to collaboration with international designers such as Karim Rashid, Giampiero Peia, Fabio Rotella, the Collections masterfully combine aesthetics, functionality and reliability.



1952

Fondata nel 1952 da Liborio Soldi e battezzata CISAL, la società ha attraversato tutte le stagioni dell'epopea della rubinetteria di cui il Cusio è protagonista fin dagli albori.

Founded in 1952 by Liborio Soldi and named CISAL, the company has gone through all the epic seasons of brassware industry where Cusio has been the protagonist since the beginning.



1980

Nel 1980 l'Arch. Raffaella Vecchi disegna la serie ARCANA, un prodotto icona classico e storico che apre nuovi orizzonti nei mercati esteri, che si sviluppano passando anche attraverso la creazione di una filiale in Germania nel 1991.

In 1980 the Architect Raffaella Vecchi, designed the ARCANA series, a classical and historical icon that opens up new horizons in foreign markets, which also led to the establishment of a daughter company in Germany in 1991.



1981

Dal lavoro di sviluppo interno coordinato da Daniele Sirini, nasce la prima cartuccia a dischi ceramici monocomando. Il nuovo BLITZ apre la gloriosa storia delle serie di miscelazione Cisol.

The first single handle ceramic disc cartridge was developed internally by Daniele Sirini and his team. The glorious history of Cisol mixer series begins with the new BLITZ series.



1999

Nel 1999, viene realizzato un nuovo stabilimento disegnato dall'Arch. Giampiero Peia e attrezzato con modernissimi impianti di cogenerazione, galvanica e magazzino elettronico. Qui si concentrano le tecnologie più avanzate del settore e si supporta una crescita continua nella progettazione del prodotto, nell'ingegnerizzazione del manufatto e del prodotto finito.

In 1999, a new factory building designed by the architect Giampiero Peia was built and equipped with modern cogeneration and plating plants along with an electronic warehouse. Here, using the most advanced technologies in the industry, product design and the engineering of the part and the finished product are in continuous development.



2009

Nel 2009 la famiglia Huber, proprietaria di Huber, leader nella fabbricazione di miscelatori termostatici, decide di fare una scelta strategica per il futuro, acquisendo Cisol per garantirle un asse di sviluppo tecnologico e industriale assolutamente vincente: combinare know-how, esperienza e capacità produttive per offrire al progettista e alla clientela una variegata e completa gamma di prodotti integrati a miscelazione termostatica, monocomando e tradizionale.

In 2009 the Huber family, owner of Huber, a leading manufacturer of thermostatic mixers, decided to make a strategic choice for the future, by acquiring Cisol and providing the company with an absolutely successful technological and industrial development format: to combine know-how, experience and production capacities in order to offer designers and customers a wide and complete range of single lever, traditional, and thermostatic brassware products.



2016

Nel 2016 l'Architetto Fabio Rotella entra a far parte del team dell'azienda e in qualità di art director ha ideato "CISALAtelier", centro creativo che, attraverso la ricerca e la sperimentazione, lavora su progetti di prodotti sempre più protagonisti, grazie ad un autentico appeal.

Architect Fabio Rotella joining the team in 2016 as the brand art director, he developed the "CISALAtelier" concept, a creative network which, through research and experimentation, will be protagonist on projects of key products thanks to their authentic appeal.



ECCELLENZA MADE IN ITALY

Cisal rappresenta un capitolo importante della storia della rubinetteria italiana. Una lunga tradizione di ingegno, mestiere e professionalità, declinata ed esaltata nel rispetto e nella considerazione per l'uomo ed il territorio: il Lago d'Orta, luogo in cui si concentra da generazioni il distretto della rubinetteria, retaggio di artigianalità e cultura del saper fare italiano.

MADE IN ITALY EXCELLENCE

Cisal represents an important chapter in the history of Italian brassware. A long tradition of ingenuity, skill and professionalism, identified and enhanced in respect and consideration for humans and the territory: Lake Orta, the area where taps have been made for generations, has a heritage of craftsmanship and a culture of Italian know-how.



cisal *Atelier* CONCEPT

L'acqua è l'elemento essenziale per l'essere umano e il suo controllo è importante sin dall'antichità. Il rubinetto, dispensatore del liquido vitale del quale facciamo un utilizzo quotidiano, è un prodotto funzionale e necessario ma può anche rappresentare un accessorio sofisticato, prezioso e sempre più protagonista nell'ambiente bagno. Cisal storicamente ha da sempre caratterizzato la sua vasta gamma di collezioni con un atteggiamento di ricerca formale riferito al design. Più recentemente, con l'integrazione delle competenze della famiglia Huber, Cisal si è ulteriormente elevata ad ancora più alti livelli di qualità e prestigio, affermandosi come un importante interprete del settore bagno e cucina a livello internazionale.

Nel 2016 l'Architetto Fabio Rotella entra a far parte del team dell'azienda e in qualità di art director ha ideato "CISALAtelier", centro creativo che, attraverso la ricerca e la sperimentazione, lavora su progetti di prodotti sempre più protagonisti, grazie ad un autentico appeal.

"In questi anni di grandi cambiamenti, in un contesto internazionale sempre più sofisticato e in continua evoluzione, Cisal, nella sua nuova visione strategica, intende sviluppare ed elevare la propria immagine rendendola unica e riconoscibile, e aumentare la percezione dei suoi prodotti e delle sue innovazioni sullo scenario globale. Nuovi materiali, nuove finiture, nuovi dettagli e nuove tecnologie per controllare e preservare l'acqua. Cisal si presenta come un'azienda Italiana di tradizione e all'avanguardia, proiettata verso il futuro e sempre più attenta alle attese di designers e utilizzatori e alla salvaguardia dell'elemento essenziale per il Pianeta: l'acqua."

Fabio Rotella

Water is the essential element for the human being - and controlling it has been important since ancient times.

The tap, dispenser of this vital liquid of which we use daily, is a functional and necessary product, but it can also be a sophisticated, precious accessory as well that plays an increasingly important role in the bathroom environment. Since its origin, Cisal's wide range of collections have always been characterized by formal research related to design. Recently, with the integration of the expertise of the Huber family, Cisal has elevated its already high levels of quality and prestige even further, establishing itself internationally as a major interpreter of the bathroom and kitchen industry.

Architect Fabio Rotella joining the team in 2016 as the brand art director, he developed the "CISALAtelier" concept, a creative network which, through research and experimentation, will be used on projects of key products thanks to their authentic appeal.

"During these years of great change, in an international context that is becoming more sophisticated and is constantly evolving, Cisal, with its new strategic vision, aims to develop and enhance its image, making it unique and recognizable, and to globally increase the perception of its products and innovations. New materials, new finishes, new details and new technologies to control and preserve water. Cisal is a cutting-edge, future-oriented Italian company that is rich in tradition and is increasingly aware of the expectations of designers and users, and the preservation of the essential element of our planet: water."

Fabio Rotella



WATER CREATIVITY



VITA Collection

design by Karim Rashid

Natura, energia
e silhouette
organica.

*Nature, energy
and an organic
silhouette.*

VITA



18

VI 51
Monocomando Lavabo
Basin Mixer



19

Per la collezione VITA
ho voluto creare forme
organiche morbide e
consensuali. Le forme
ispirate al ramo e al bambù
sono contemporanee
ma naturali, come se si
sviluppassero dal lavabo.
Il collo assottigliato
comunica tattilità ed
esprime un piacevole
e forte confort visivo.

fantini

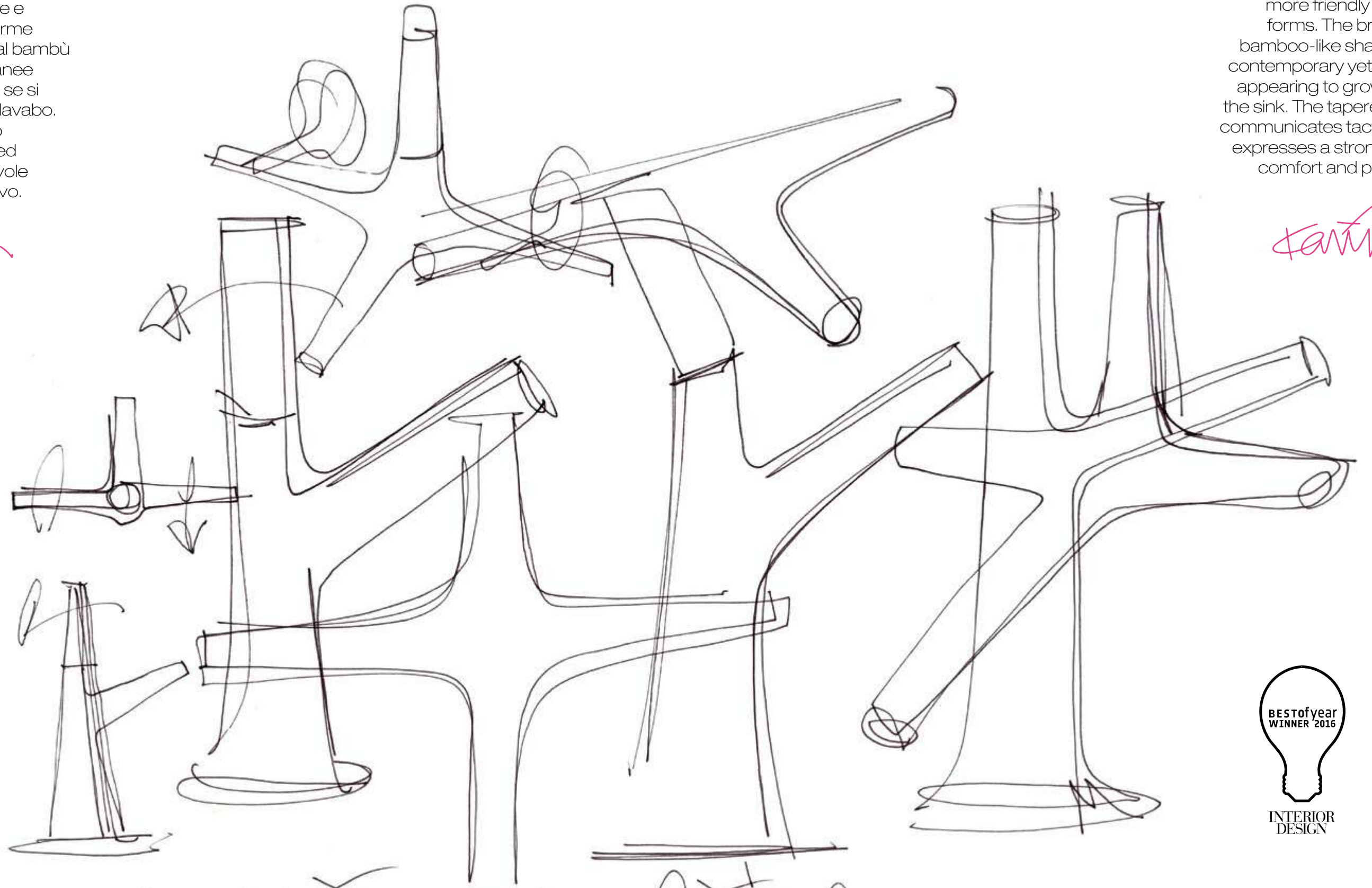

fantini for Cristal

For the Vita collection
I wanted to create softer,
more friendly organic
forms. The branch or
bamboo-like shapes are
contemporary yet natural,
appearing to grow out of
the sink. The tapered neck
communicates tactility and
expresses a strong visual
comfort and pleasure.

fantini



INTERIOR
DESIGN



VITA migliora la funzionalità pura, offrendo un'esperienza sensoriale, intuitiva e riducendo gli ingombri. E' un onore vincere il Best Of Year Award, ma il vero riconoscimento continuo sarà vedere i miei oggetti nelle case della gente.

VITA enhances pure functionality by offering a sensual, intuitive experience and reducing encumbrances. It is an honour to win the Best of Year Award but the continual accolade will be seeing my objects in people's homes.

fantini

VI 51
Monocomando Lavabo
Basin Mixer

VITA



24



VI 51
Monocomando Lavabo
Basin Mixer

25

VITA



26

VI 354
Monocomando Lavabo
Basin Mixer



27

VITA



28

VI 55
Monocomando Bidet
Bidet Mixer



29



VITA



32

VI 1420
Completo Monocomando Vasca Free-Standing
Free-Standing Bath/S. Mixer Set



33

VITA



VITA



36

VI 13
Monocomando Vasca
Bath Mixer



37

VITA



38

VI 44
Monocomando Doccia
Shower Mixer

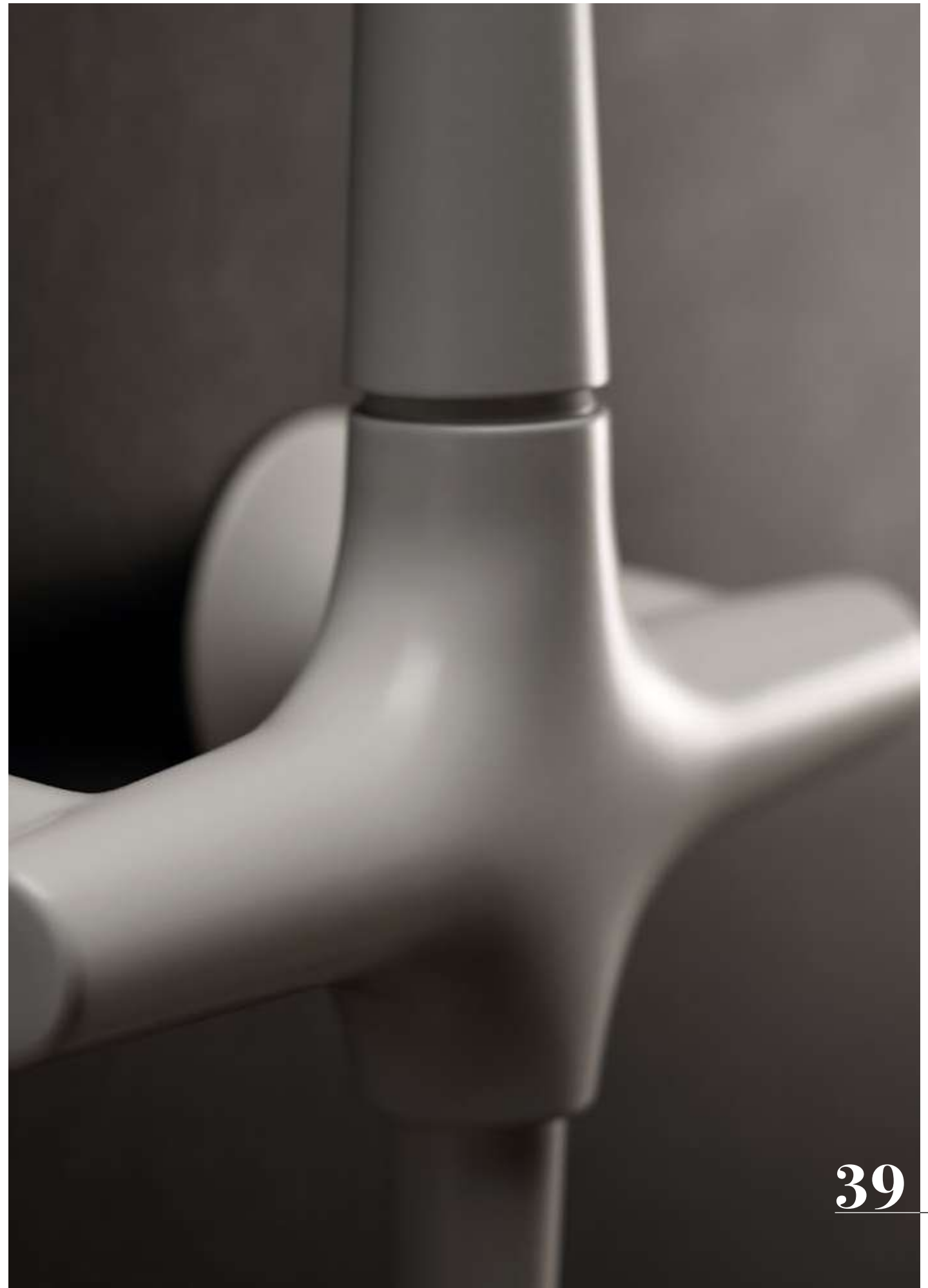

39

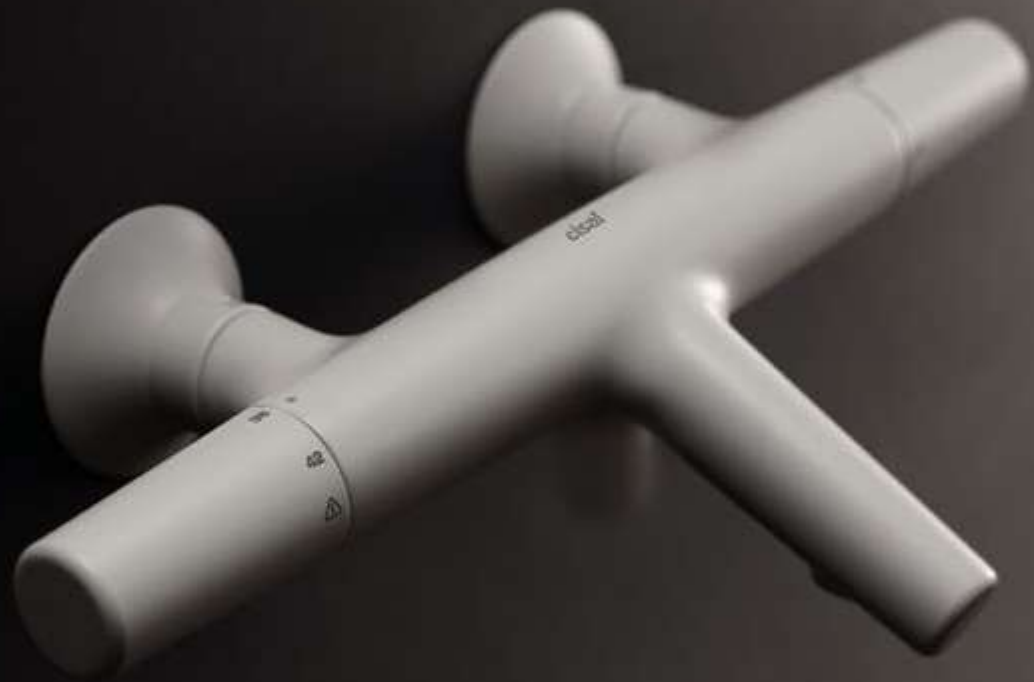





VI S0102
Completo Termostatico Doccia
Thermo Shower Set



VI 10
Completo Monocomando Vasca
Bath Mixer Set



VI 1914
Termostatico 2 Uscite
2-Outlet Thermo



VI BM03
Miscelatore 2/3 Uscite su ONE Box
ONE Box Mounted 2/3 Outlet Mixer



VI 1R20
Termostatico 2 Funzioni
2-Function Thermo



VI 1V30
Termostatico 3 Funzioni
3-Function Thermo





VI 303
Completo Doccia con Presa d'Acqua
Shower Set on Wall Elbow

VI 303
Monocomando Doccia
Shower Mixer



VI 1319
Braccio e Soffione Doccia
Shower Arm & Head

VI 1914
Termostatico 2 Uscite
2-Outlet Thermo

VI 303
Completo Doccia con Presa d'Acqua
Shower Set on Wall Elbow





VI 9061
Dispenser Sapone
Soap Dispenser

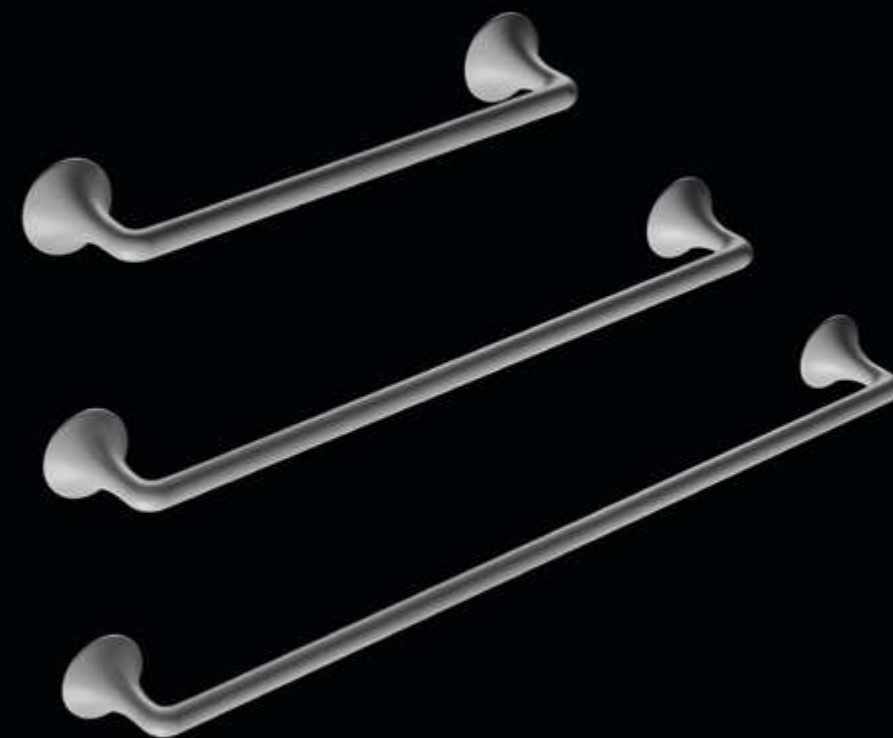

VI 9010 0 - VI 9010 1 - VI 9010 2
Porta Salviette
Towel Rail



VI 9040
Porta Rotolo
Roll Holder



VI 9071
Appendino
Robe Hook



Prodotti e Accessori
Products and Accessories
Produits et Accessoires

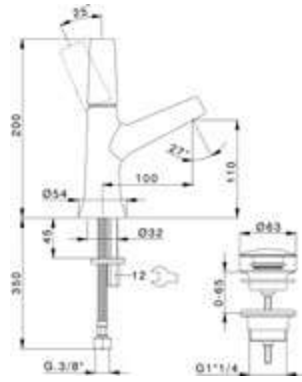

VI 000514
Monocomando Lavabo
Basin Mixer
Mitigeur Lavabo

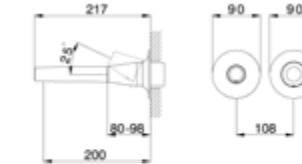

VI 005510
Parte Esterna Monocomando Lavabo
Basin Mixer Exposed Part
Partie Apparente Mitigeur Lavabo

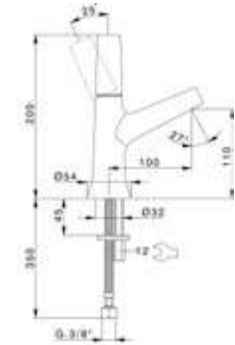

VI 000544
Monocomando Lavabo
Basin Mixer
Mitigeur Lavabo

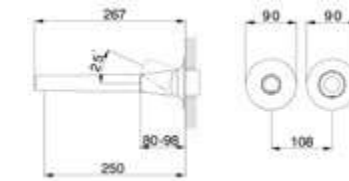

VI 005511
Parte Esterna Monocomando Lavabo
Basin Mixer Exposed Part
Partie Apparente Mitigeur Lavabo

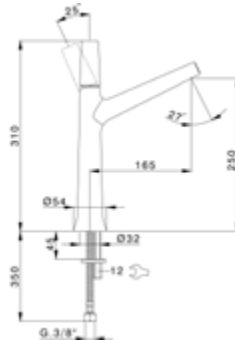

VI 003544
Monocomando Lavabo
Basin Mixer
Mitigeur Lavabo

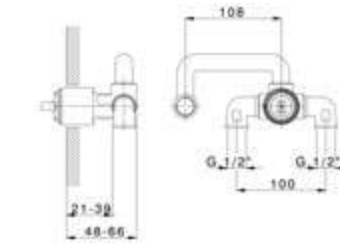

ZA 025510
Parte Incasso Monocomando Lavabo
Basin Mixer Concealed Part
Partie Encastrée Mitigeur Lavabo

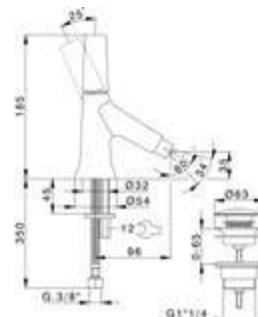

VI 000554
Monocomando Bidet
Bidet Mixer
Mitigeur Bidet

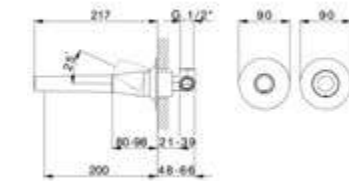

VI 002470
Completo Monocomando Lavabo
Parte Incasso + Parte Esterna
Basin Mixer Set
Concealed Part + Exposed Part
Ensemble Mitigeur Lavabo
Partie Encastrée + Partie Apparente

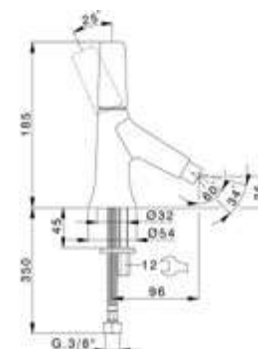

VI 000564
Monocomando Bidet
Bidet Mixer
Mitigeur Bidet

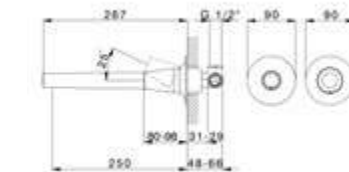

VI 002471
Completo Monocomando Lavabo
Parte Incasso + Parte Esterna
Basin Mixer Set
Concealed Part + Exposed Part
Ensemble Mitigeur Lavabo
Partie Encastrée + Partie Apparente

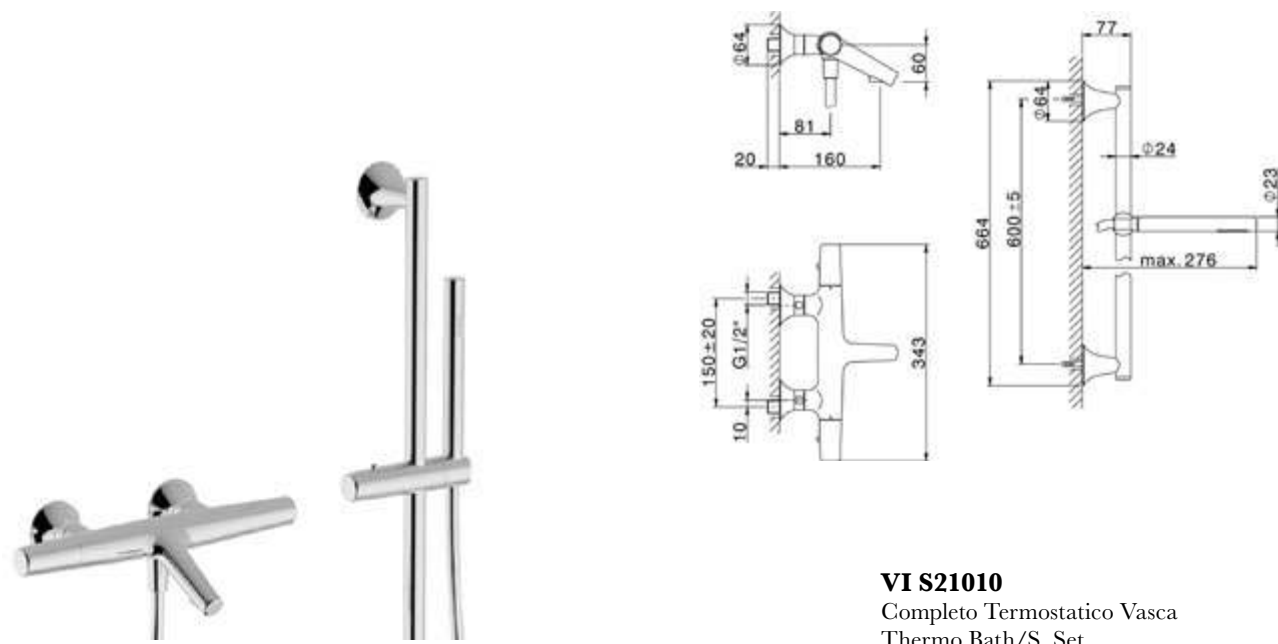

VI S21010
 Completo Termostatico Vasca
 Thermo Bath/S. Set
 Ensemble Thermo Bain/D.

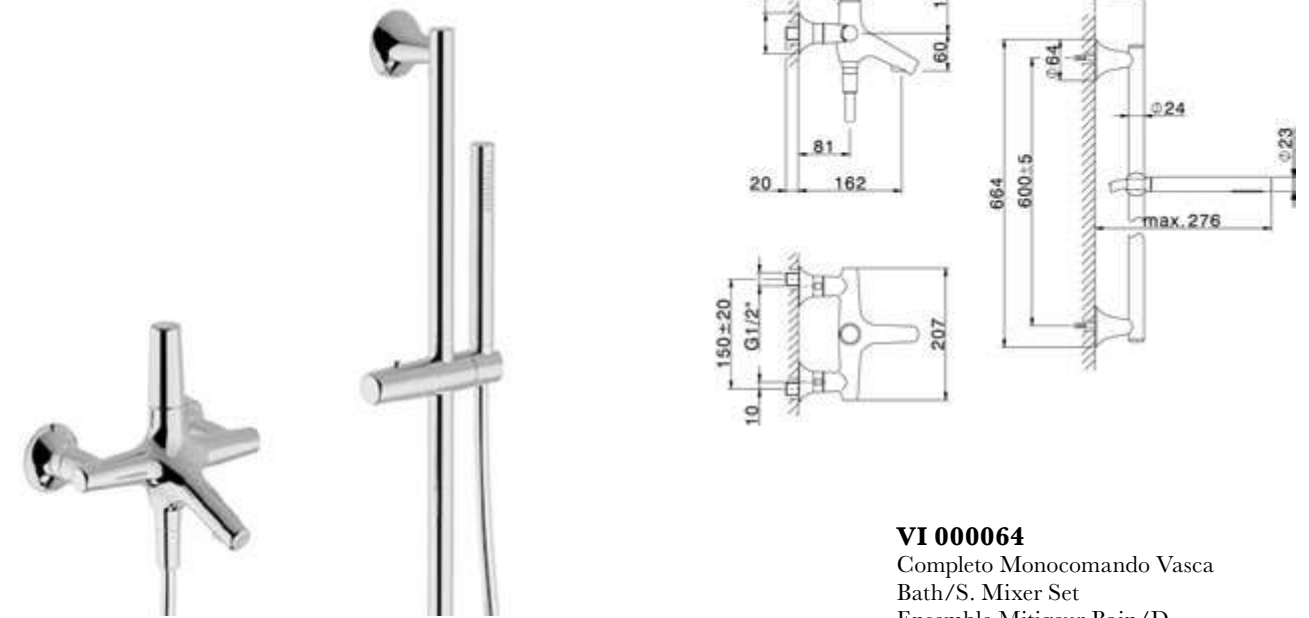

VI 000064
 Completo Monocomando Vasca
 Bath/S. Mixer Set
 Ensemble Mitigeur Bain/D.

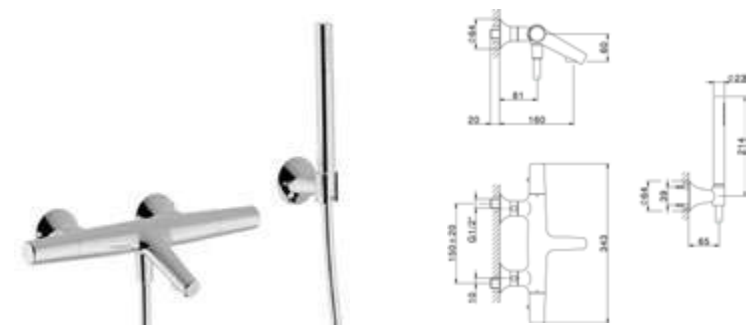

VI D21010
 Completo Termostatico Vasca
 Thermo Bath/S. Set
 Ensemble Thermo Bain/D.



VI 000104
 Completo Monocomando Vasca
 Bath/S. Mixer Set
 Ensemble Mitigeur Bain/D.



VI T21010
 Termostatico Vasca
 Bath/S. Thermo
 Thermo Bain/D.



VI 000134
 Monocomando Vasca
 Bath/S. Mixer
 Mitigeur Bain/D.

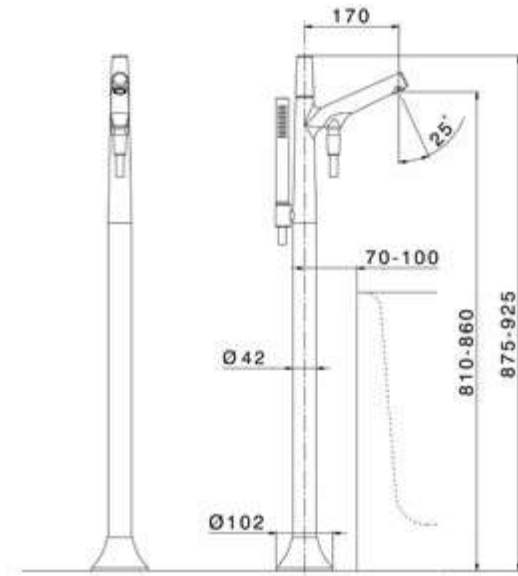

VI 014204
 Parte Esterna Monocomando Vasca Free-Standing
 Free-Standing Bath/S. Mixer Exposed Part
 Partie Apparente Mitigeur Bain/D. Free-Standing
 Vedi / See / Voir **ZA 004510**

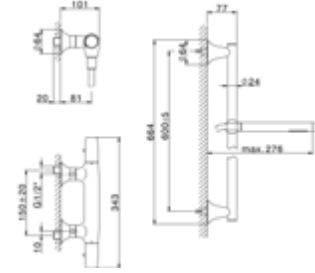

VI S01010
 Completo Termostatico Doccia
 Thermo Shower Set
 Ensemble Thermo Douche



VI T01010
 Termostatico Doccia
 Shower Thermo
 Thermo Douche

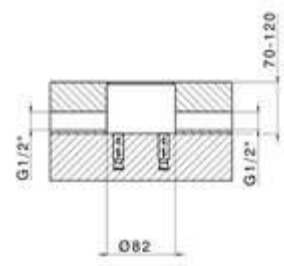

ZA 004510
 Parte Incasso Monocomando Free-Standing
 Free-Standing Mixer Concealed Part
 Partie Encastrée Mitigeur Free-Standing

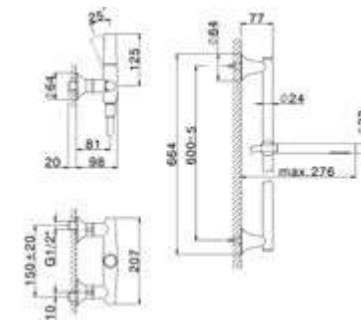

VI 000464
 Completo Monocomando Doccia
 Shower Mixer Set
 Ensemble Mitigeur Douche



VI 000444
 Monocomando Doccia
 Shower Mixer
 Mitigeur Douche

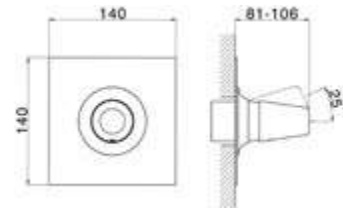

VI 003000
 Parte Esterna Monocomando Doccia
 Shower Mixer Exposed Part
 Partie Décor Mitigeur Douche

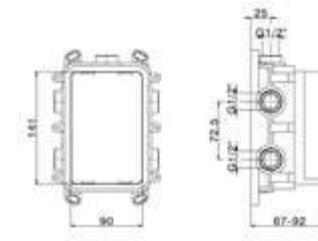

ZA 00B030
 Parte Incasso ONE Box
 ONE Box Concealed Part
 Partie Encastrée ONE Box

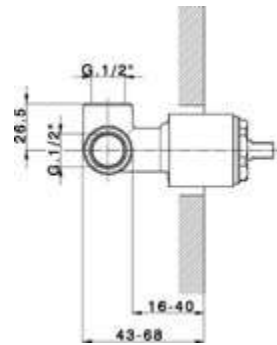

ZA 005300
 Parte Incasso Monocomando Doccia
 Shower Mixer Concealed Part
 Partie Encastrée Mitigeur Douche

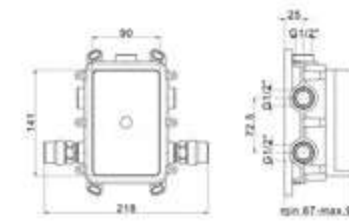

ZA 00B031
 Parte Incasso ONE Box con Silenziatori
 ONE Box Concealed Part with Noise Reducers
 Partie Encastrée ONE Box avec Silencieux

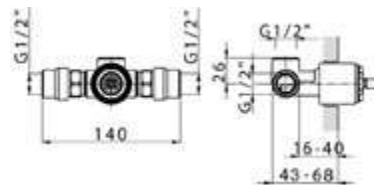

ZA 005301
 Parte Incasso Monocomando Doccia con Silenziatori
 Shower Mixer Concealed Part with Noise Reducers
 Partie Encastrée Mitigeur Douche avec Silencieux

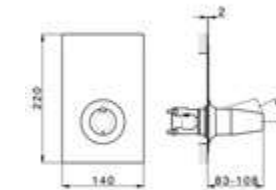

VI 0BM010
 Parte Esterna Monocomando 1 Uscita
 1 Outlet Mixer Exposed Part
 Partie Décor Mitigeur 1 Sortie
 per / for / pour ONE Box

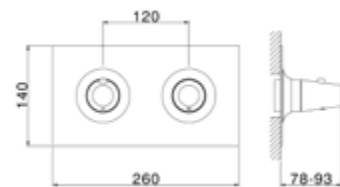

VI 019140
 Parte Esterna Termostatico 2 Uscite
 2-Outlet Thermo Exposed Part
 Partie Décor Thermo 2 Sorties

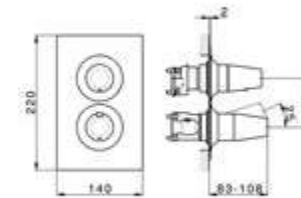

VI 0BM030
 Parte Esterna Monocomando 2/3 Uscite
 2/3 Outlet Mixer Exposed Part
 Partie Décor Mitigeur 2/3 Sorties
 per / for / pour ONE Box

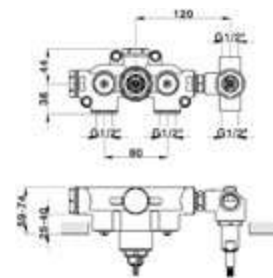

ZA 019140
 Parte Incasso Termostatico 2 Uscite
 2-Outlet Thermo Concealed Part
 Partie Encastrée Thermo 2 Sorties

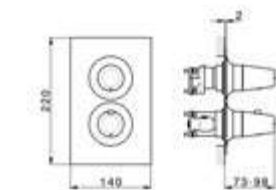

VI 0BT030
 Parte Esterna Termostatico 1/2/3 Uscite
 1/2/3 Outlet Thermo Exposed Part
 Partie Décor Thermo 1/2/3 Sorties
 per / for / pour ONE Box

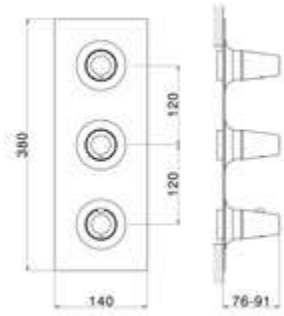

VI 01V200
 Parte Esterna Termostatico 2 Funzioni
 2-Function Thermo Exposed Part
 Partie Décor Thermo 2 Fonctions

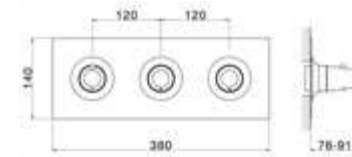

VI 01R200
 Parte Esterna Termostatico 2 Funzioni
 2-Function Thermo Exposed Part
 Partie Décor Thermo 2 Fonctions

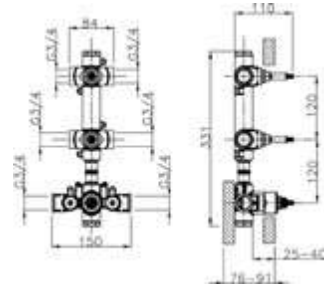

ZA 01V200
 Parte Incasso Termostatico 2 Funzioni
 2-Function Thermo Concealed Part
 Partie Encastrée Thermo 2 Fonctions

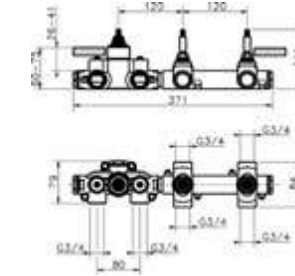

ZA 01R200
 Parte Incasso Termostatico 2 Funzioni
 2-Function Thermo Concealed Part
 Partie Encastrée Thermo 2 Fonctions

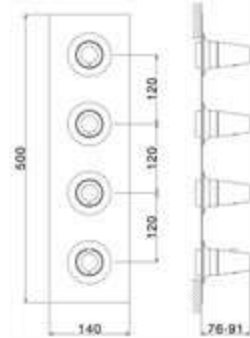

VI 01V300
 Parte Esterna Termostatico 3 Funzioni
 3-Function Thermo Exposed Part
 Partie Décor Thermo 3 Fonctions

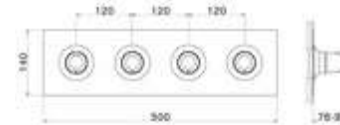

VI 01R300
 Parte Esterna Termostatico 3 Funzioni
 3-Function Thermo Exposed Part
 Partie Décor Thermo 3 Fonctions

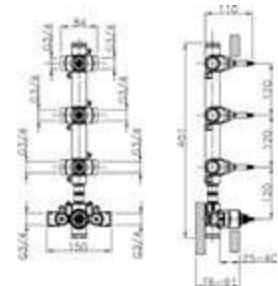

ZA 01V300
 Parte Incasso Termostatico 3 Funzioni
 3-Function Thermo Concealed Part
 Partie Encastrée Thermo 3 Fonctions

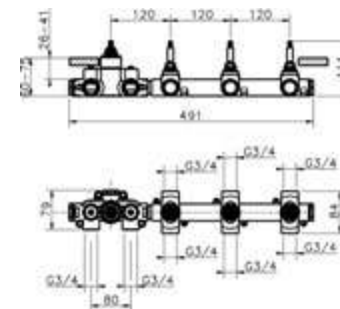

ZA 01R300
 Parte Incasso Termostatico 3 Funzioni
 3-Function Thermo Concealed Part
 Partie Encastrée Thermo 3 Fonctions

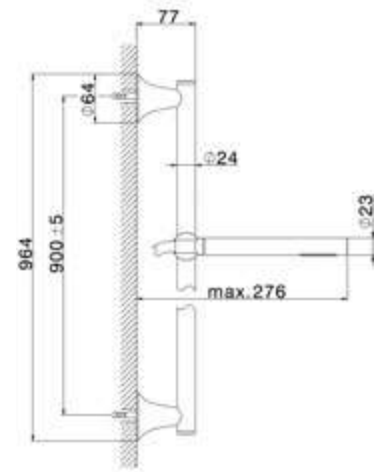

VI 003111
Completo Doccia Saliscendi 90 cm
90 cm Slide Rail Shower Set
Ensemble Barre de Douche 90 cm



VI 003033
Completo Doccia con Presa d'Acqua
Shower Set on Wall Elbow
Ensemble de Douche sur Coude Mural

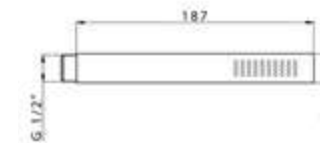

DS 014460
Doccetta Ottone
Brass Hand Shower
Douchette à Main Laiton

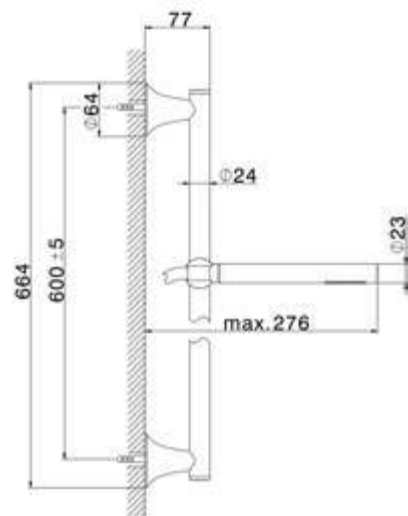

VI 003110
Completo Doccia Saliscendi 60 cm
60 cm Slide Rail Shower Set
Ensemble Barre de Douche 60 cm

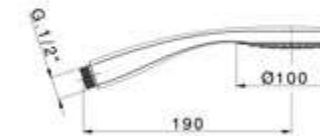

DS 014480
Doccetta
Hand Shower
Douchette à Main

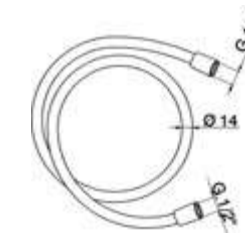

ZA 009040
Flessibile Doccia SUPREME
SUPREME Shower Hose
Flexible de Douche SUPREME

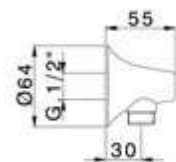

VI 017000
Presa d'Acqua
Wall Elbow
Coude Mural

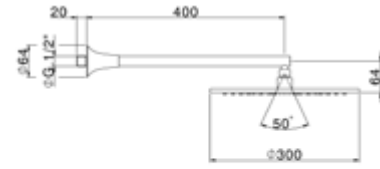

VI 013190
Braccio e Soffione Doccia
Shower Arm & Head
Bras et Tête de Douche

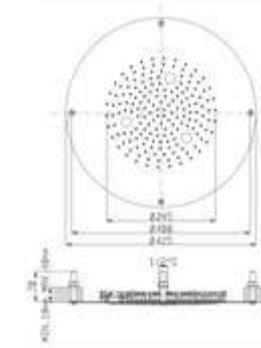

ZS 027180
Soffione Doccia a Controsoffitto Cromoterapia,
Funzione Pioggia, 3 Led RGB
Ceiling Mounted Shower Head,
Rain Function, 3 Led RGB
Ciel de Pluie Encastré, Fonction Pluie
3 Led RGB

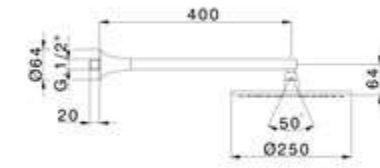

VI 013191
Braccio e Soffione Doccia
Shower Arm & Head
Bras et Tête de Douche

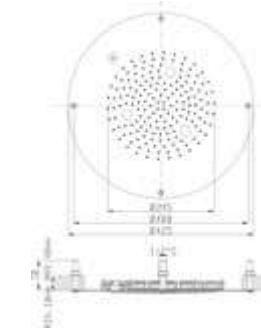

ZS 027170
Soffione Doccia a Controsoffitto Cromoterapia,
Funzione Pioggia, 3 Led RGB - con Pulsantiera
Ceiling Mounted Shower Head, Rain Function,
3 Led RGB - with Remote Control
Ciel de Pluie Encastré, Fonction Pluie,
3 Led RGB - avec Commande



DS 013700
Braccio e Soffione Doccia
Shower Arm & Head
Bras et Tête de Douche

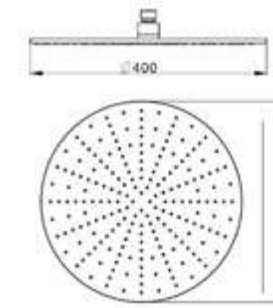

DS 016370
Soffione Doccia
Shower Head
Douche de Tête

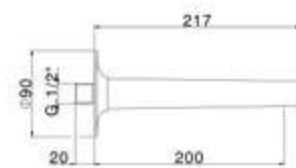

VI 000240
Bocca di Erogazione
Filler Spout
Bec Verseur

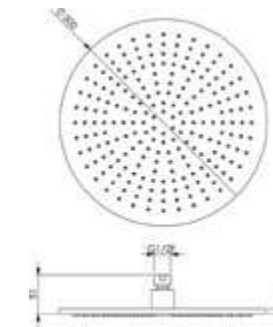

DS 016330
Soffione Doccia
Shower Head
Douche de Tête

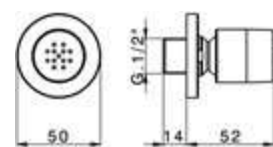

DS 015090
Soffione Laterale
Body Jet
Buse Murale

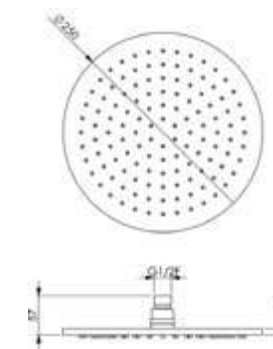

DS 016350
Soffione Doccia
Shower Head
Douche de Tête

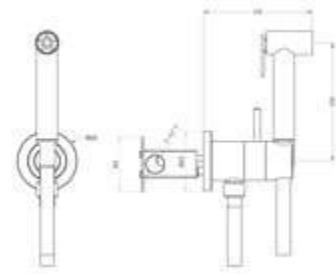

CY 007945
Set Miscelatore Doccetta Igienica
Bidet Hand Shower Mixer Set
Kit Mitigeur Douche d'Hygiène

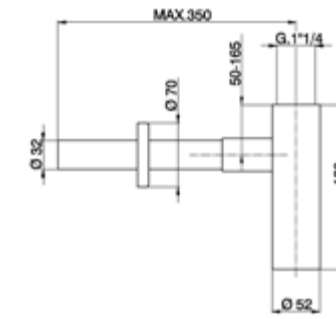

ZA 004070
Sifone
Siphon
Siphon

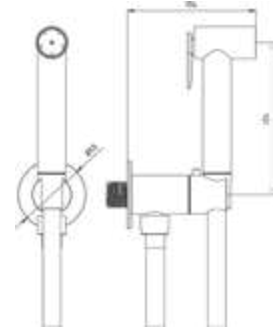

CY 007920
Set Doccetta Idroscopino
Toilet-Jet Hand Shower Set
Kit Douche pour Cuvette

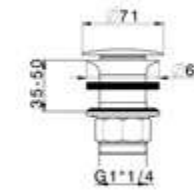

ZA 001610
Scarico Sempre Aperto
Open Flow Waste
Vidage Ouvert

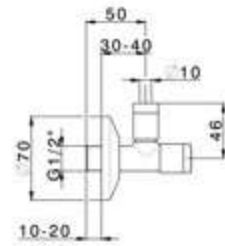

ZA 002900
Rubinetto Filtro di Alimentazione
Angle Valve
Robinet à Equerre

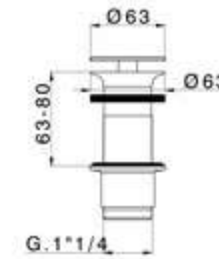

ZA 001613
Scarico Sempre Aperto
Open Flow Waste
Vidage Ouvert

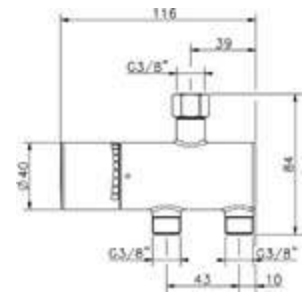

TX T83010
Termostatico Sottolavabo
Underbasin Thermo
Thermo Sous Lavabo

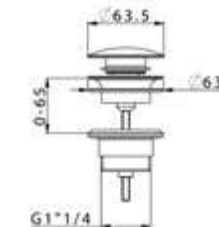

ZA 001780
Scarico Click-Clack
Click-Clack Waste
Vidage Click-Clack

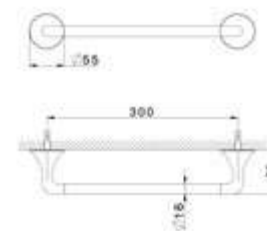

VI 090100
Porta Salviette
Towel Rail
Porte-Serviette

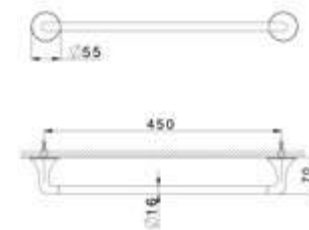

VI 090101
Porta Salviette
Towel Rail
Porte-Serviette

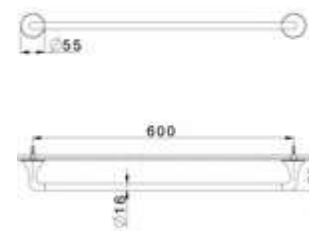

VI 090102
Porta Salviette
Towel Rail
Porte-Serviette

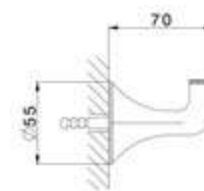

VI 090710
Appendino
Robe Hook
Porte-Peignoir

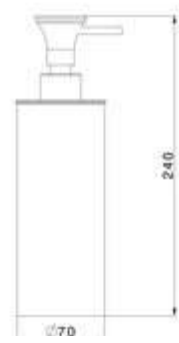

VI 090610
Dispenser Sapone
Soap Dispenser
Diffuseur de Savon

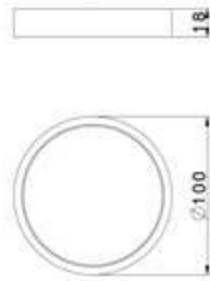

VI 090490
Porta Sapone
Soap Holder
Porte-Savon

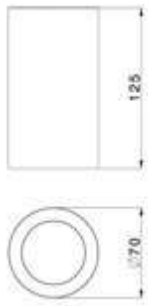

VI 090470
Bicchiere
Toothbrush Holder
Verre

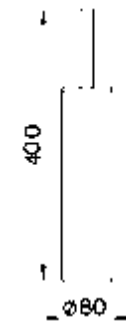

VI 090650
Porta Scopino
Brush Holder
Porte-Brosse

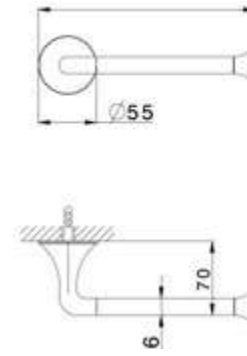

VI 090400
Porta Rotolo
Roll Holder
Porte-Papier

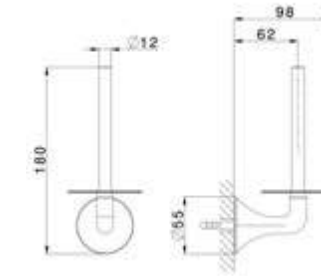

VI 090410
Porta Rotolo
Roll Holder
Porte-Papier

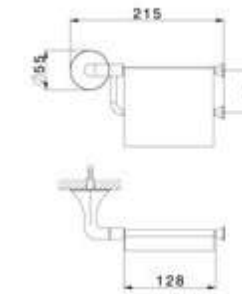

VI 090420
Porta Rotolo
Roll Holder
Porte-Papier

METALLI CLASSICI | CLASSIC METALS



Chrome
21

METALLI SPECIALI PVD | PVD SPECIAL METALS



Black Titanium
2Q

COLORI | COLOURS



Snow White
4Q



Night Black
40

Art Direction Studio Rotella

CREDITS

Text and Editing
CISAL Atelier

Art Direction
Fabio Rotella

Graphic Design and Layout
Studio Rotella Milano

Photography
Dario De Sirianna
Marco Siracusano

Printing
Tipolitografia Testori

Thanks to
"Museo del Rubinetto e della sua Tecnologia"

Printed in Italy

cisal

cisal

cisal



CISAL
28010 Alzo di Pella (NO) - Italia - Via Pietro Durio 160 - Tel. +39 0322 918111 - Fax +39 0322 969518
cisal@cisal.it - www.cisal.it