

PEŠTAN
CON  **LUO**
SMART DRAINS



WE ARE

We are privately held company Peštan, leader in the Balkans in production and distribution of products and solutions from polymers.

Company was founded in 1989 and has been producing water pipes made of polyethylene. Over time, we introduced new materials (polypropylene and PVC) and expanded product range. Today, in our offer you may find more than 6 500 products, divided into four categories:



**PIPING
SOLUTIONS**



**BATHROOM
SOLUTIONS**



**AGRICULTURE
SOLUTIONS**



**HOUSEHOLD
SOLUTIONS**

“Walk in” showers represent new and elegant solution for bathroom. A barrier-free shower concept inspired and motivated us to create Confluo Smart Drains program. We made our Confluo drains of high quality materials, modular, easy to install and clean, cost effective and with modern design, in order to satisfy all customer needs. With more then 350 different models in our offer, we believe we can meet all their needs.

Dive into our Confluo Drains and discover your new gem in bathroom!

Advantages of Confluo shower drains:

- Huge product portfolio — more than 350 different models
- Modularity
- Modern design
- High functionality
- Best buy products





Quality and functionality |



Confluo icons



1 Min. installation height

Minimal construction height of drain, from bottom of the base, up to the holder of the grid.

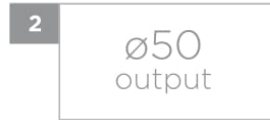

2 Base diameter outlet

Diameter of base outlet.



3 Maximum flow rate

Maximum flow rate with 20 mm threshold.



4 Base inlet diameter

Diameter of base inlet.



5 Anti-leaking system

Anti-Leaking System represents combination of drain construction and proper installation which allows all leaked and condensated water to go back to drain.

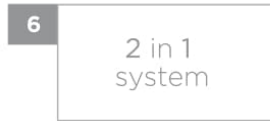

6 2 in 1 system

Grid of drain can be turned and used both for stainless steel/gold and ceramic/glass finish.



7 Base rotation

Base of drain can be rotated 360 degrees.



8 Fine output adjustment

Output of drain can be adjusted by 15 degrees.



9 Water seal height



10 Fine ceramic adjustment

Model have system for ceramic height leveling, so clients have flexibility in choosing surface in bathroom.



11 Self-cleaning base

Output of drain is constructed in way that whatever goes through grid for hair will for sure go through output and then through sewage system.



12 Handicapped accessible

Easy access to the shower.



13 Material of grid

Grid is made of stainless steel AISI 304. Optionally, we can produce grid from stainless steel AISI 316.

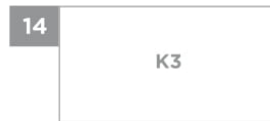

14 Load class of grid

Grid is classified as K3, which means that it can withstand 300kg of pressure.



15 Ceramic adjustment

Unlimited ceramic height leveling.

Confluo Linear drains

We produce our Confluo Linear drains in 3 different models (Premium Line, Slim Line and Frameless line), 9 different sizes (300, 450, 550, 650, 750, 850, 950, 1050 and 1150 mm) and 3 different grid finishes (Stainless Steel, Glass and Gold). All models, except Slim, have 2 in 1 system where the same model can be used both with Stainless Steel/Gold and Tile/Glass finish and are characterized as ultra low 360 degrees rotatable self-cleaning S base.

Confluo Wall drain

As Peštan Company always follows trends on world market, we have prepared for our customers the latest model in world of shower drains — Wall drain. This model represents innovation in industry and, besides its new and modern design, it is perfect model for renovations and bathrooms with concealed cisterns. Wall drain has body made of plastic and it is supplied with 2 different grids (Stainless Steel and Gold).

Confluo Board

Peštan "Board" program of preinstalled shower drains represents the result of constant searching for better and more efficient solutions for our customers worldwide. With this product, we made a big step ahead concerning waterproofing, safety and aesthetic, as we have minimized possibility of mistake and significantly reduced the time and effort for installation. With this product, as a producer, we have taken responsibility on our side and made modern, quality and time effective solutions for our clients.

Confluo Standard drains

Peštan Company offers to clients more than 150 different models of Confluo Standard drains. All models have body made of plastic and grid made of stainless steel, glass or gold, which we deliver in various designs (Tide, Square, Drops, Black & White Glass, Ceramic and Gold) and sizes (10x10 cm, 15x15 cm and 20x20 cm). Main advantages are: Big variety of models, maximum flow rate, modular and flexible systems with 6 different output, 3 different types of siphons. You can make your own floor drain system easy for installation and maintenance.

Confluo Garden and Roof drains

In our program of outside drainage, we have 2 models — Confluo Top and Confluo Gardino. Confluo Top is used for drainage of water on flat roofs, and Confluo Gardino is made for driveways and garages. Main advantages of this models: Maximum flow rate, modular and flexible system with 4 different outputs, drainage/anti-leaves system, easy installation and maintenance.





Ultra low S base

Main advantages:

1. 360 degrees rotation
2. Superior flow rate — 48 l/min
 - DN 50 mm output
3. Ultra low — 50 mm
4. Acute angle of siphon — 40 degrees
5. Self-cleaning
 - Smooth plastic
 - Wide channel for water, without any obstacles

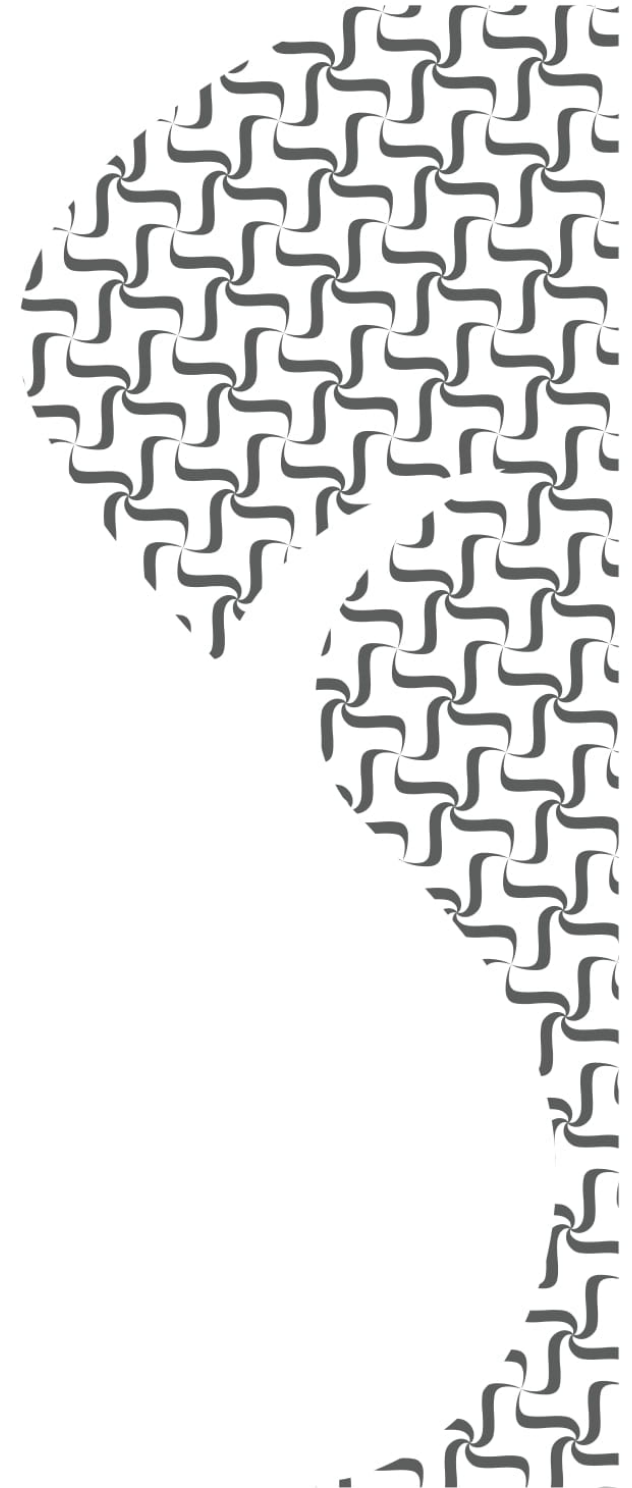



Confluo Premium Line is characterized with 2 in 1 reversible grid system which enables you to change your bathroom design on daily basis with stainless steel/ceramic or black & white glass/stainless steel finish and decorative mask that covers all plastic parts. Model has superior flow rate of 48 l/min and minimum installation height of only 52 mm, which makes our Confluo Premium Line the lowest drain in the world with DN 50 mm output and perfect model for most demanding renovation projects.

Confluo Premium Line

Main advantages:

- Minimum installation height — 52 mm
- Maximum flow rate — 48 l/min
- Reversible grid — 2 in 1 system
- 360 degrees rotatable self-cleaning S base
- Without visible plastic parts

Dimensions: 300, 450, 550, 650, 750, 850, 950 mm

Grid Design

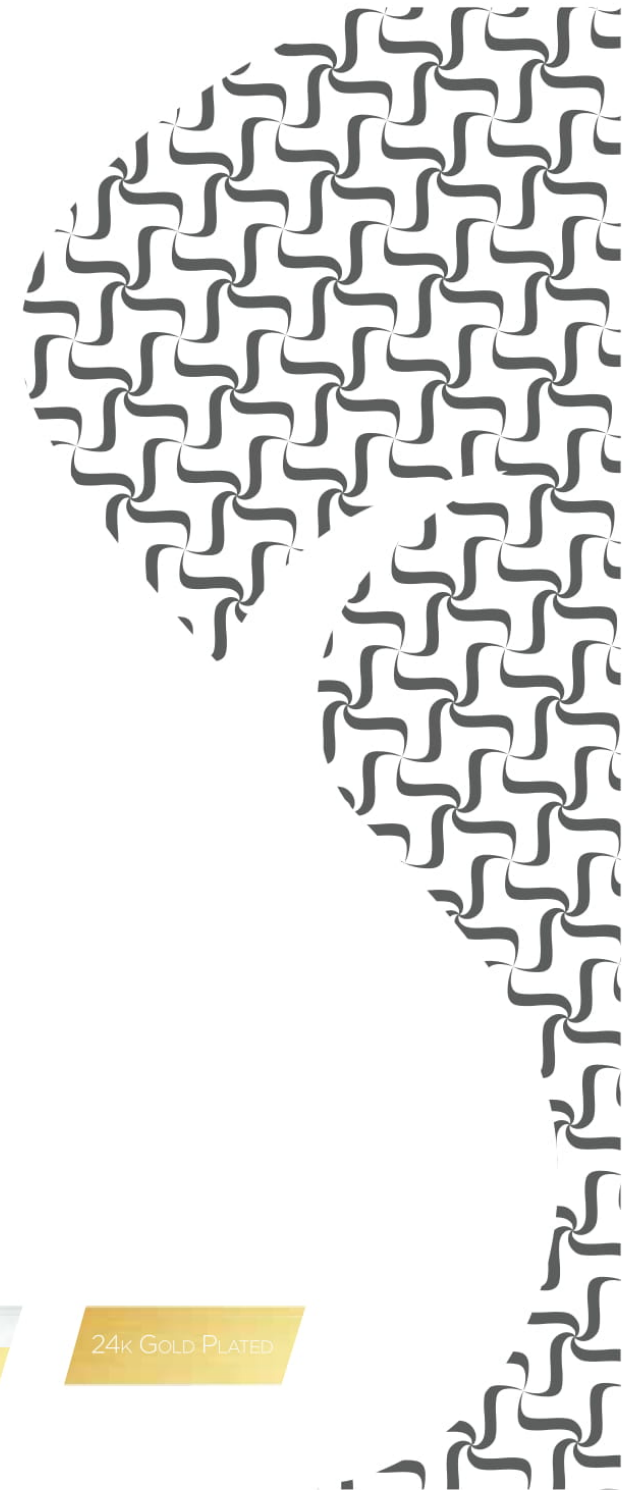



Dry siphon for linear drains with O-Ring included for extra protection against bad smells and insects when water evaporate from S base.

* Not included in standard product. Needs to be ordered separately.



CONFLUO PREMIUM LINE

Premium 300 Premium 450 Premium 550 Premium 650 Premium 750 Premium 850 Premium 950



Legend:

1. Ultra low S Base
2. Height adjustment legs
3. Reducer with rubber ring
4. Grid holder
- 5.1 Grid for hair — flow rate 48l/min
- 5.2 Dry siphon — flow rate 26l/min
6. Mask
7. Grid
8. Protective styrofoam

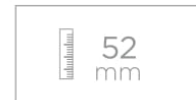

Min. installation height

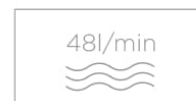

Maximum flow rate

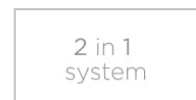

2 in 1 system



Self-cleaning base



Load class of grid

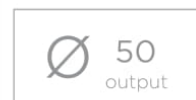

Base diameter outlet



Base rotation



Water seal height



Material of grid



Stainless steel/Ceramic

White Glass/
24k Gold Plated

12 in 1 System & Grid design



Black Glass/
24k Gold Plated

24k Gold Plated

White Glass/
Stainless steel

Black Glass/
Stainless steel

Stainless steel/
Ceramic

n options



For all your needs



Elegance that your
bathroom deserves





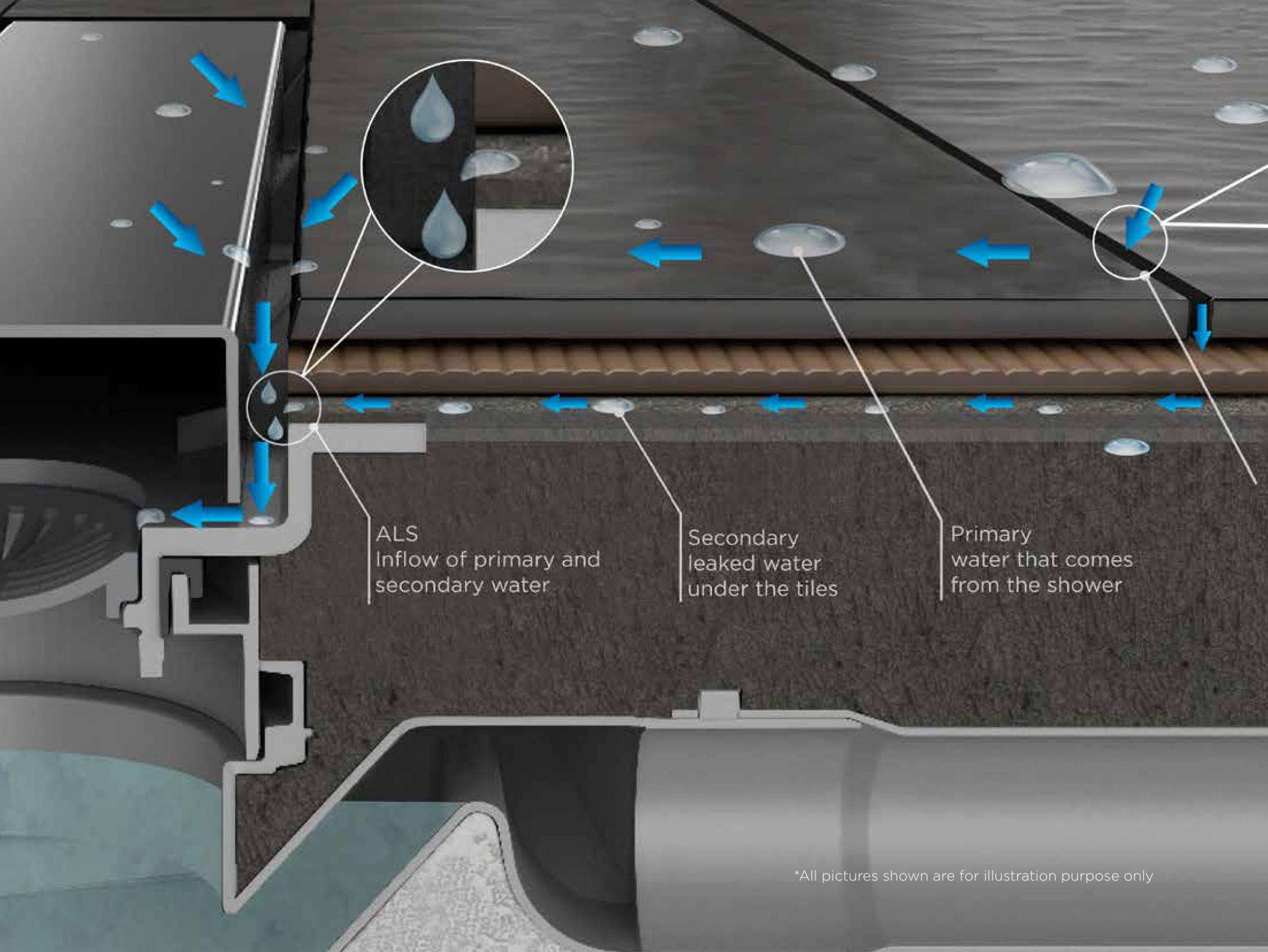

ALS
Inflow of primary and
secondary water

Secondary
leaked water
under the tiles

Primary
water that comes
from the shower

*All pictures shown are for illustration purpose only

ALS

ANTI-LEAKING SYSTEM

ALS – Anti-Leaking System represents combination of drain construction and proper installation, which allows all leaked and condensated water under the tiles to go back to the drain.

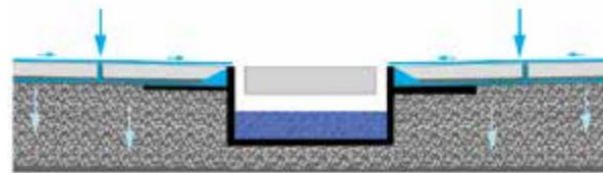
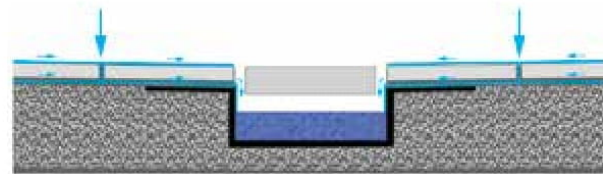

During the years, water in bathroom has tendency to build under the tiles as consequence of erosion of grout and moisture in the bathroom. Usually it takes 5–7 years until this problem happens and then a leakage shows up in a place where waterproofing was finished. We have solved this problem with our construction of grid holder, where you have no barrier for water under the tiles. Also, in order that this system works properly, it is very important to do correct slope screed and proper waterproofing as per our instruction manual.

Cross section of linear drain

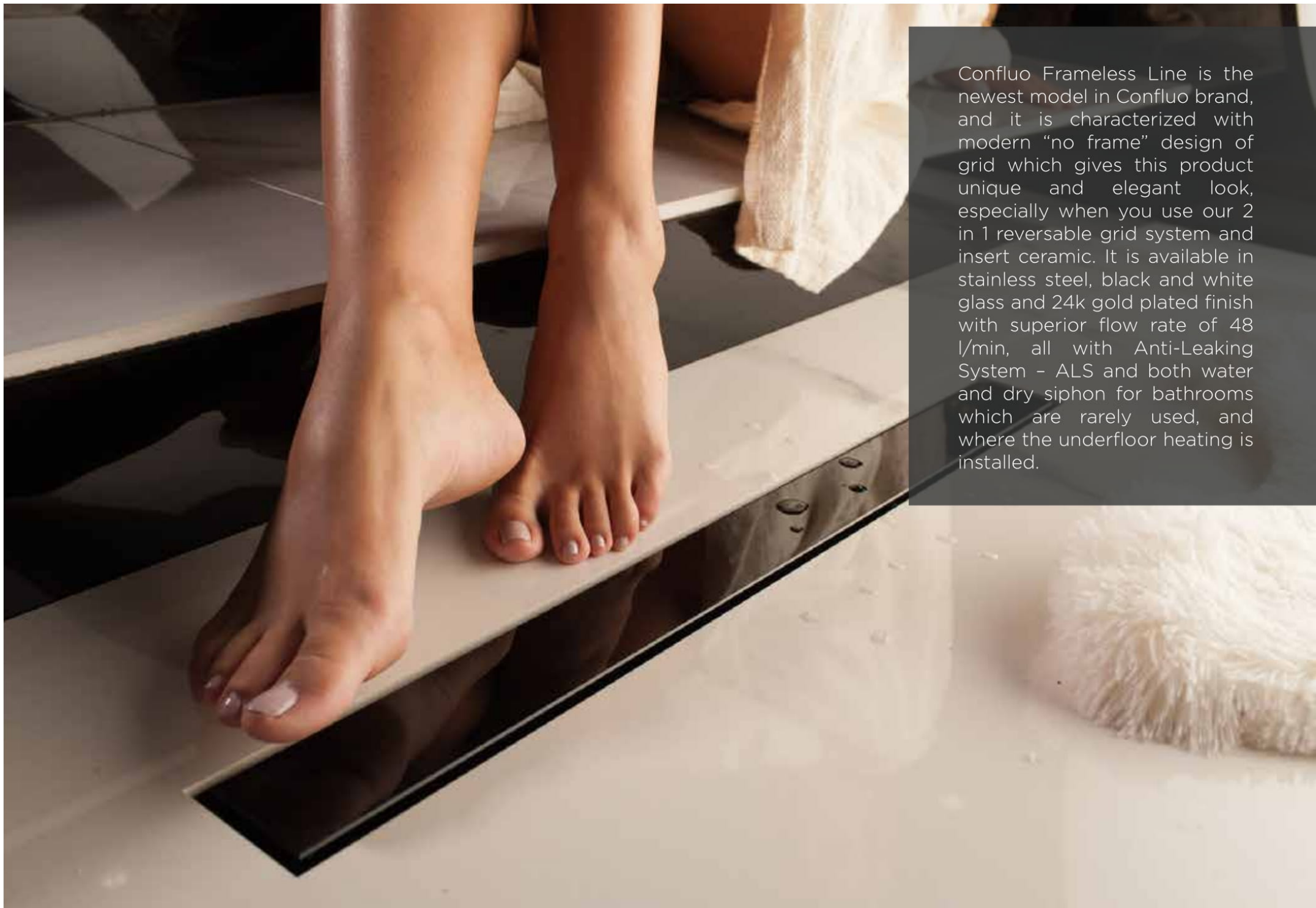

Confluo Frameless Line is the newest model in Confluo brand, and it is characterized with modern “no frame” design of grid which gives this product unique and elegant look, especially when you use our 2 in 1 reversable grid system and insert ceramic. It is available in stainless steel, black and white glass and 24k gold plated finish with superior flow rate of 48 l/min, all with Anti-Leaking System - ALS and both water and dry siphon for bathrooms which are rarely used, and where the underfloor heating is installed.

Confluo **Frameless** Line

Main advantages:

- Minimum installation height — 62 mm
- Maximum flow rate — 48 l/min
- ALS — Anti-Leaking System
- Reversible grid — 2 in 1 system
- 360 degrees rotatable self-cleaning S base
- Combined siphon — wet + dry

Dimensions: 300, 450, 550, 650, 750, 850, 950, 1050, 1150 mm

Grid Design

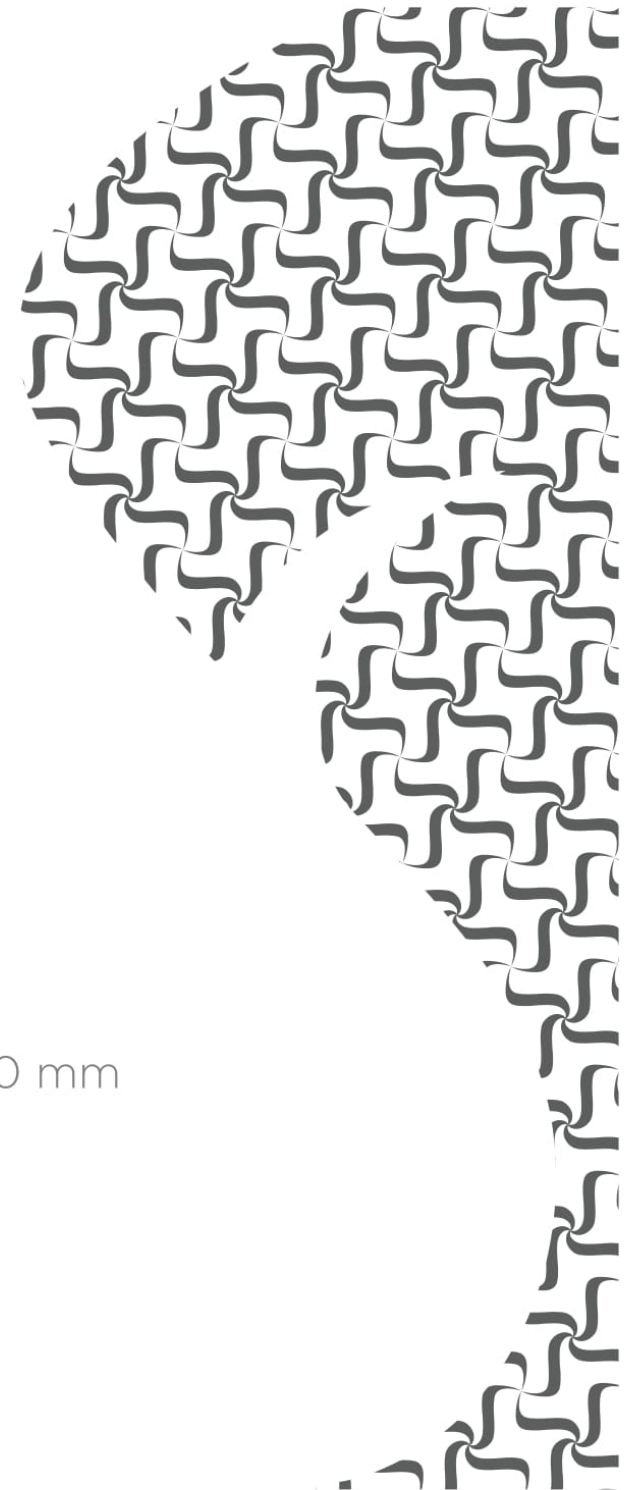



Dry siphon for linear drains with O-Ring included for extra protection against bad smells and insects when water evaporate from S base.

* Included in standard product.



Confluo Frameless styrofoam with dual role — Protection during the installation of the drain and and benchmark for perfect leveling of ceramic.



CONFLUO FRAMELESS LINE

FRAMELESS 300 FRAMELESS 450 FRAMELESS 550 FRAMELESS 650 FRAMELESS 750 FRAMELESS 850 FRAMELESS 950 FRAMELESS1050 FRAMELESS 1150



Legend:

1. Ultra low S Base
2. Height adjustment legs
3. Reducer with rubber ring
4. Holder of grid
- 5.1 Grid for hair — flow rate 48l/min
- 5.2 Dry siphon — flow rate 26l/min
6. Grid
7. Protective styrofoam

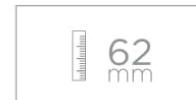

Min. installation height

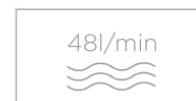

Maximum flow rate



Self-cleaning base



Load class of grid



Anti-leaking system



Base diameter outlet



Base rotation

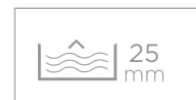

Water seal height



Material of grid

Grid design options & 2 in 1 System

Stainless steel/Ceramic

Black Glass/Stainless steel



24k Gold Plated

Black Glass/Stainless steel

White Glass/Stainless steel

Stainless steel/Ceramic



Modern functionality

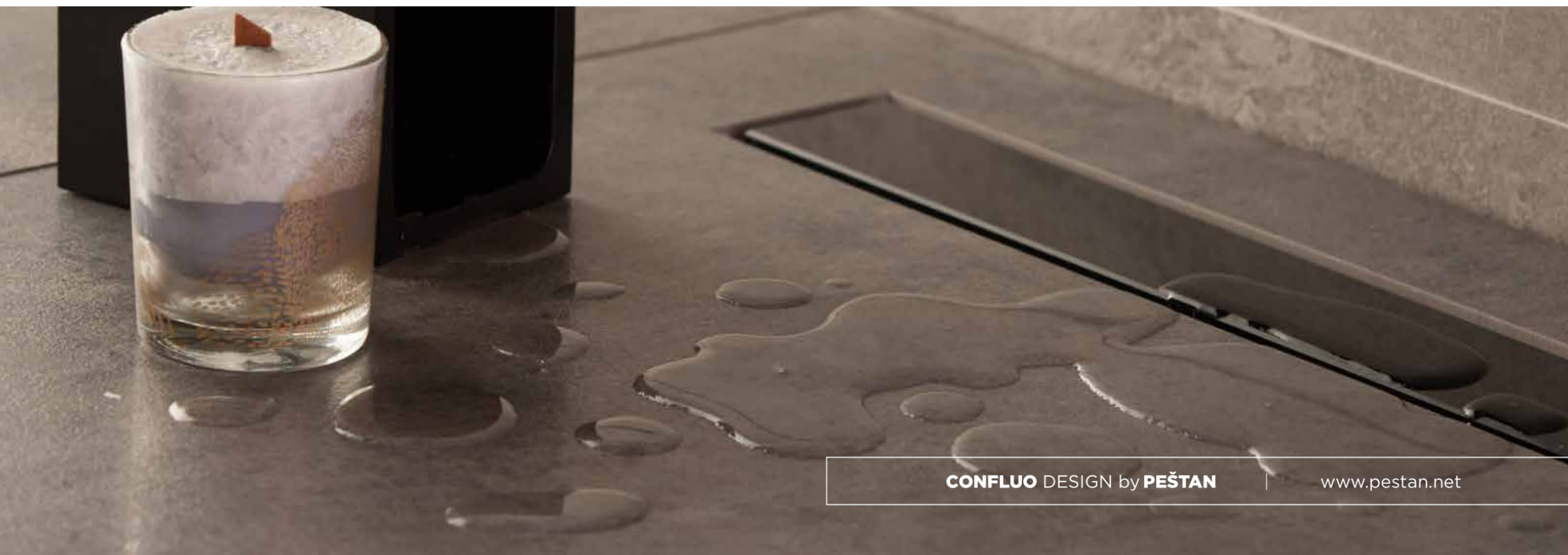



Minimalistic design





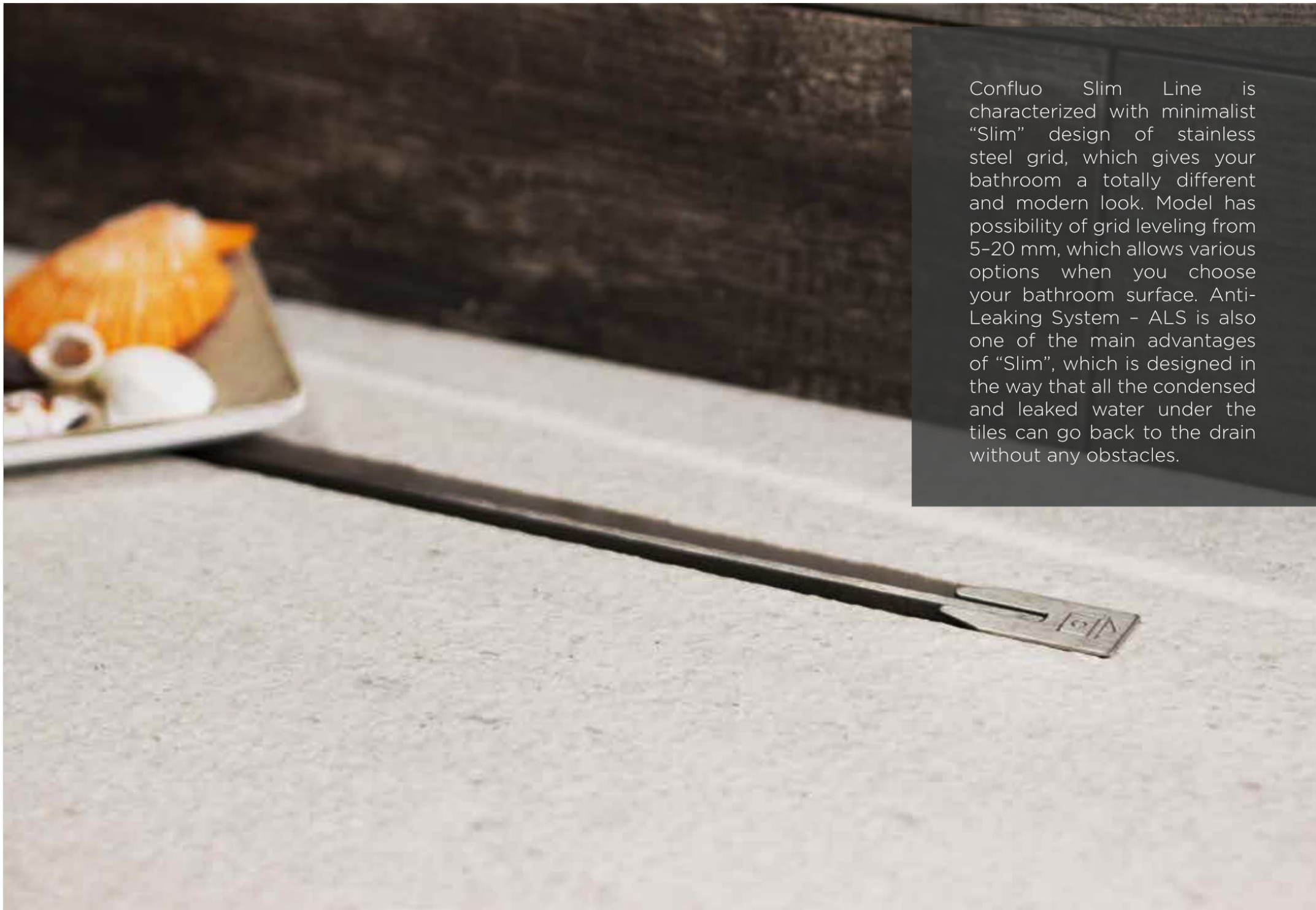

Confluo Slim Line is characterized with minimalist "Slim" design of stainless steel grid, which gives your bathroom a totally different and modern look. Model has possibility of grid leveling from 5-20 mm, which allows various options when you choose your bathroom surface. Anti-Leaking System - ALS is also one of the main advantages of "Slim", which is designed in the way that all the condensed and leaked water under the tiles can go back to the drain without any obstacles.

Confluo **Slim** Line

Main advantages:

- Minimum installation height — 72 mm
- ALS — Anti-Leaking System
- Unique and minimalist design of grid
- 360 degrees rotatable self-cleaning S base
- Height adjustable grid — 5—20 mm

Dimensions: 300, 450, 550, 650, 750, 850, 950, 1050, 1150 mm

Grid Design

STAINLESS STEEL

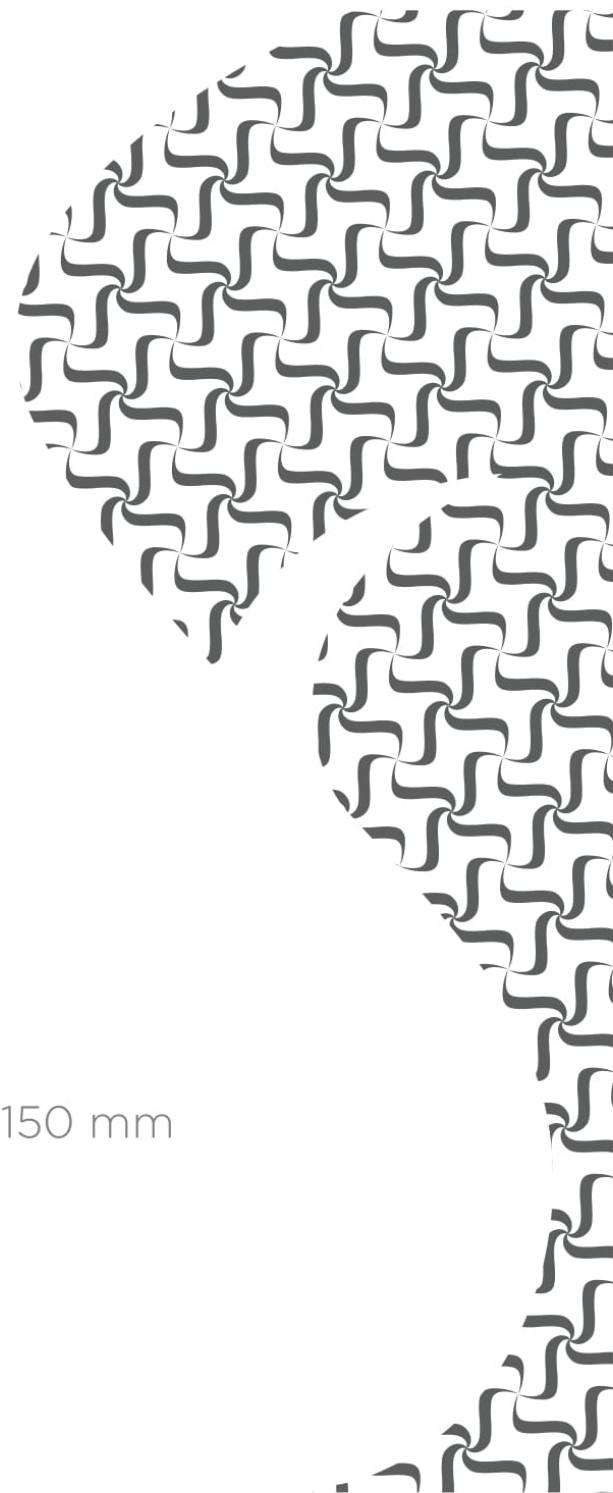



CONFLUO SLIM LINE

Slim 300 Slim 450 Slim 550 Slim 650 Slim 750 Slim 850 Slim 950 Slim 1050 Slim 1150



Legend:

1. Ultra low S Base
2. Height adjustment legs
3. Reducer with rubber ring
4. Holder of grid
5. Grid for hair
6. Decorative Plate
7. Grid
8. Aluminum profile for ceramic

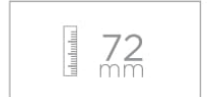

Min. installation height

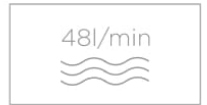

Maximum flow rate



Self-cleaning base



Water seal height



Handicapped accessible

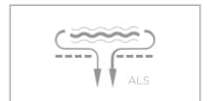

Anti-leaking system

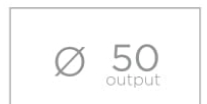

Base diameter outlet

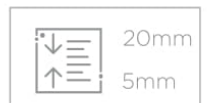

Fine ceramic adjustment

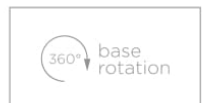

Base rotation



Confluo Wall Drain is innovative concept in shower drains industry. Possibility of positioning the drain into the wall instead of floor gives your bathroom huge number of possibilities, both technically and design-wise. Model has Anti-Leaking System - ALS, superior flow rate of 48 l/min, minimum installation height of 56 mm and installation depth of 80 mm, which makes this model perfect for bathrooms with concealed cisterns and renovation projects with limited space.

Confluo **Wall** drain

Main advantages:

- Minimum installation height — 56 mm
- Maximum flow rate — 48 l/min
- ALS — Anti-Leaking System
- 360 degrees rotatable self-cleaning S base
- Perfect model for renovations and bathrooms with concealed cistern

Dimensions: 300 mm

Grid Design

Stainless steel

24k GOLD PLATED

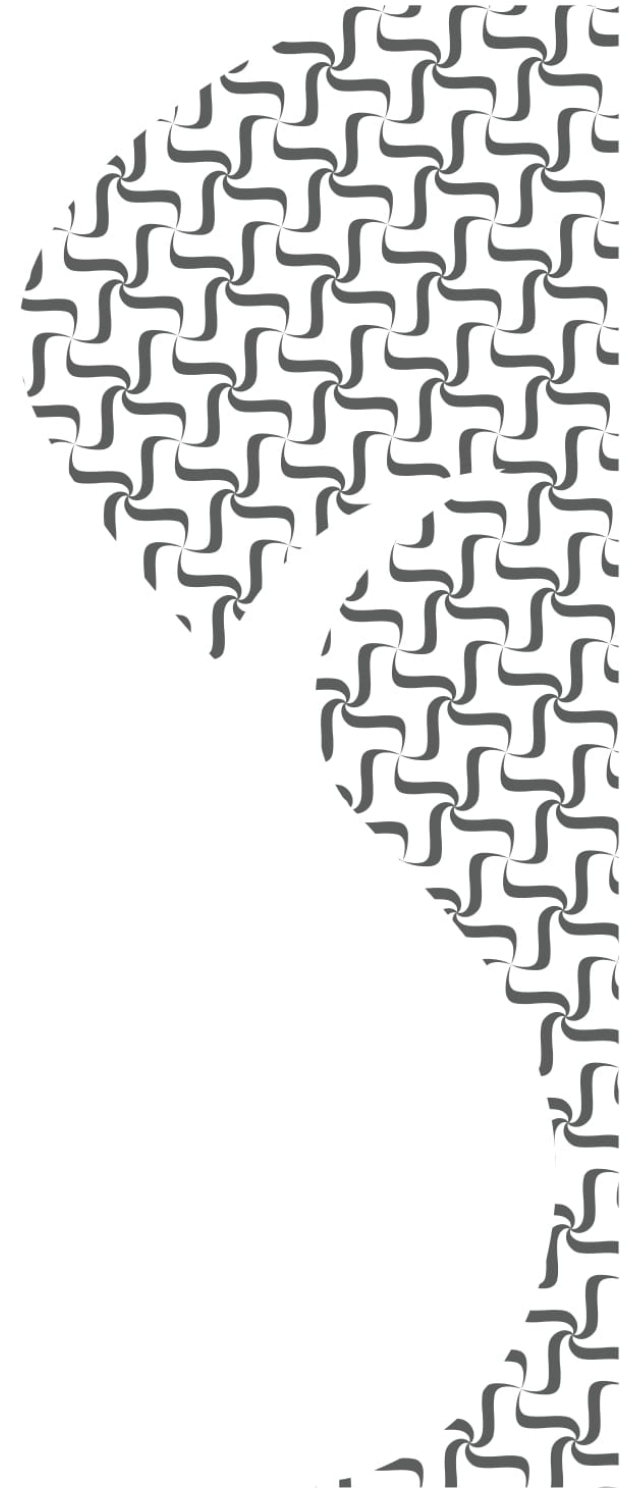



CONFLUO WALL DRAIN

WALL 300



Legend:

1. Ultra low S Base
2. Height adjustment legs
3. Reducer with rubber ring
4. Grid
5. Grid holder
6. ALS chambers



Min. installation height

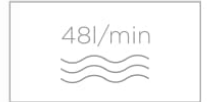

Maximum flow rate



Self-cleaning base



Water seal height



Handicapped accessible

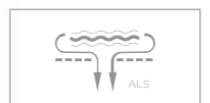

Anti-leaking system



Base diameter outlet



Base rotation

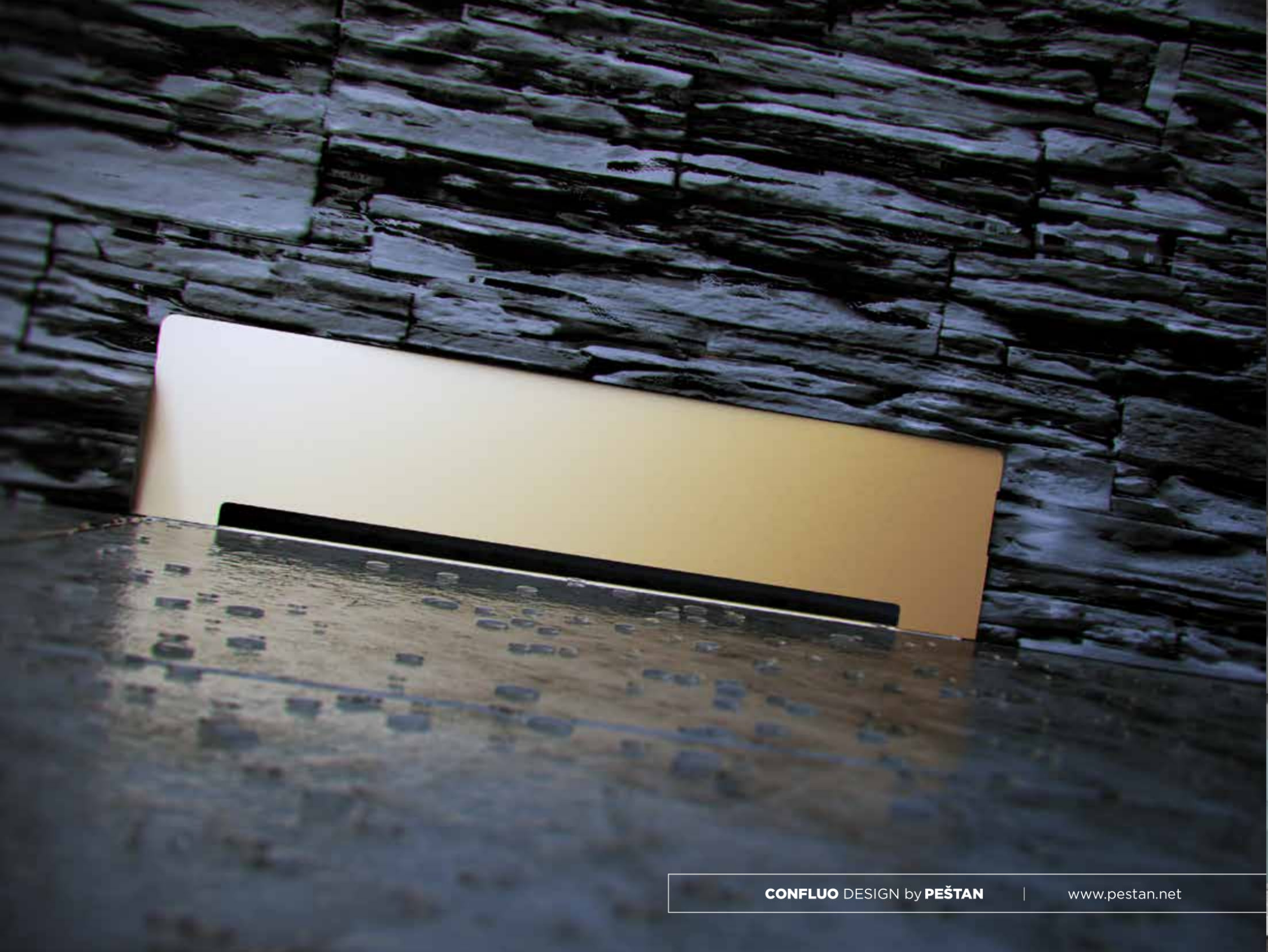

ALS ANTI-LEAKING SYSTEM

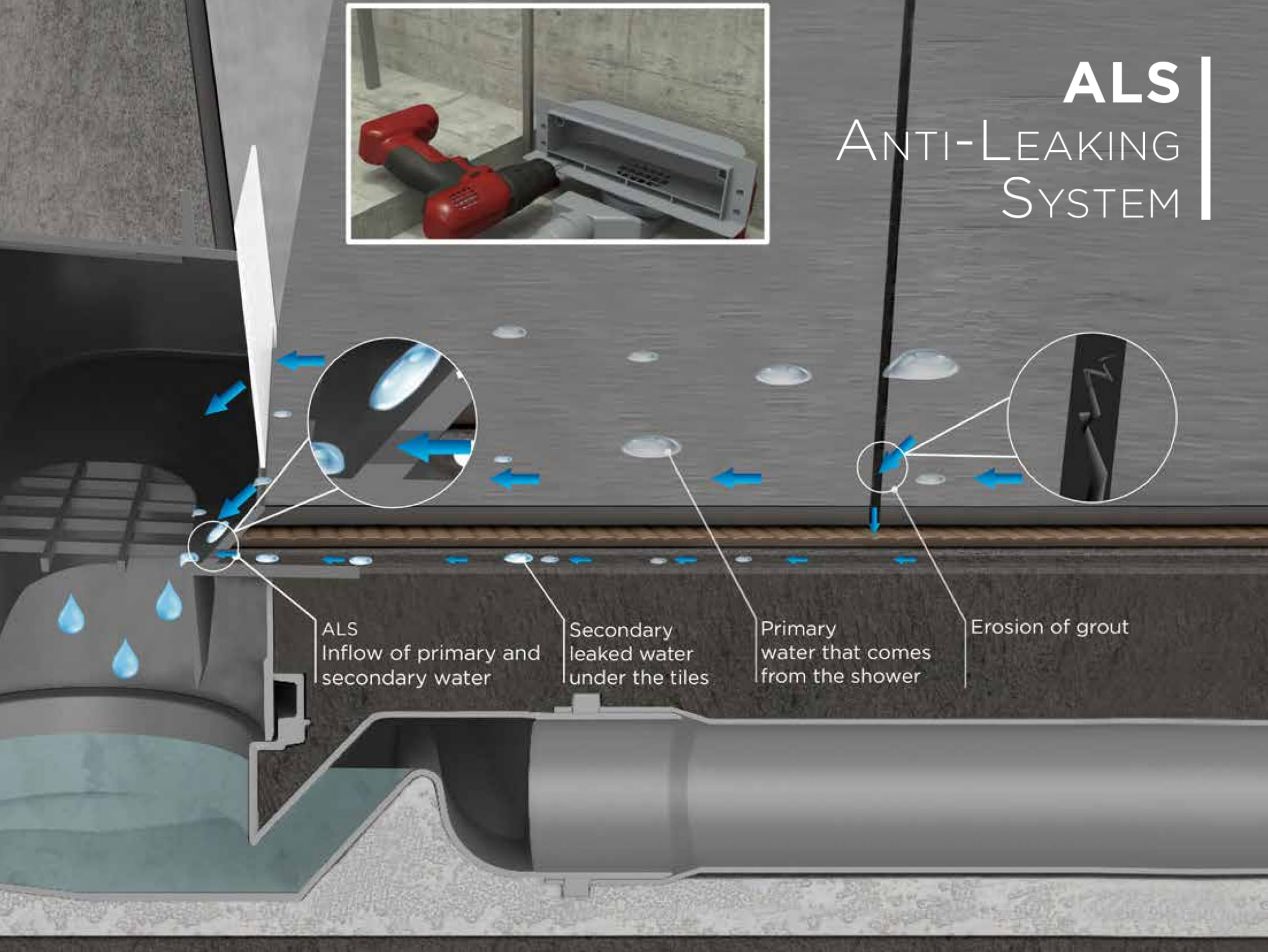

ALS
Inflow of primary and
secondary water

Secondary
leaked water
under the tiles

Primary
water that comes
from the shower

Erosion of grout

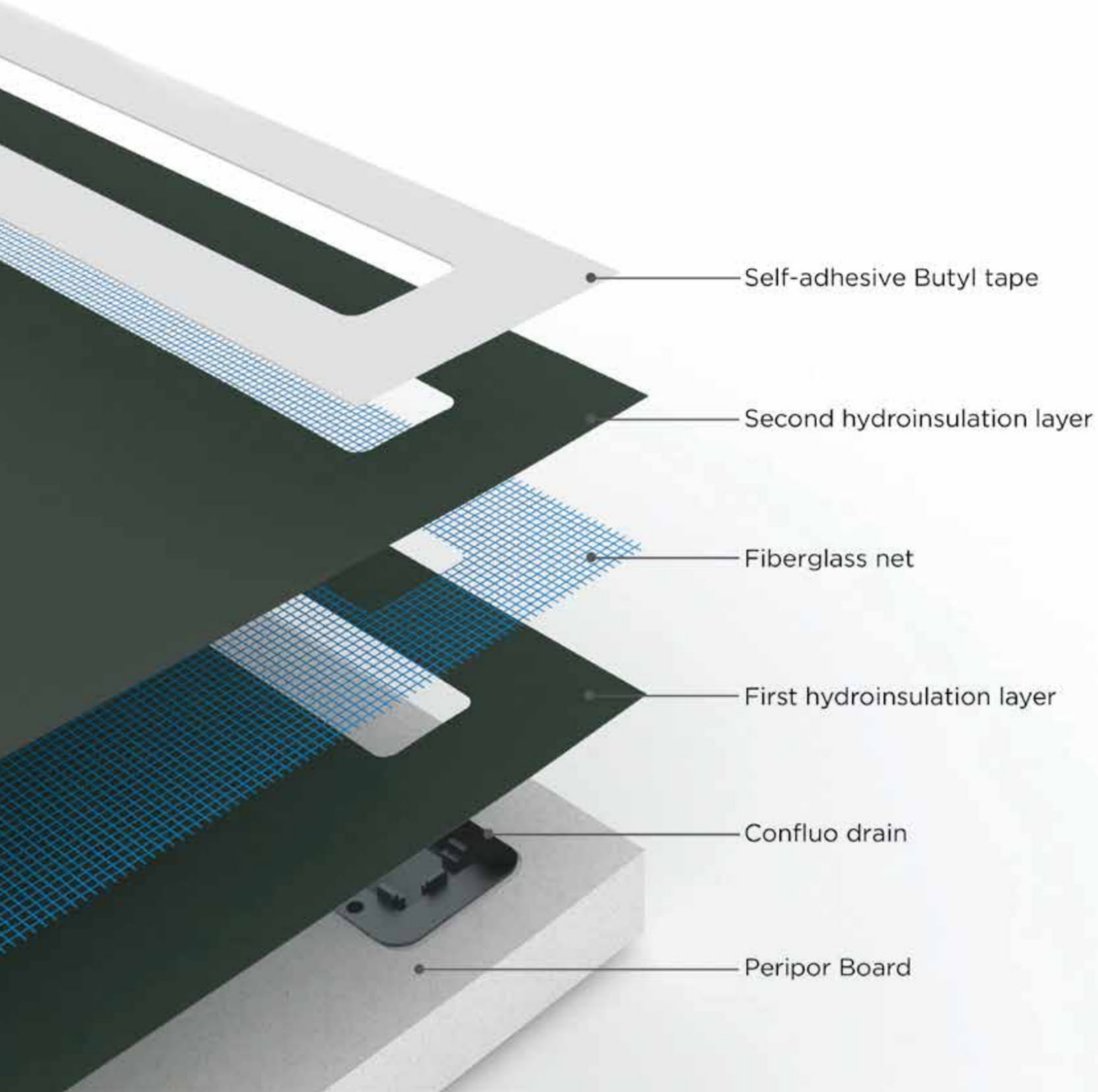

Confluo **Board**

1. **Peripor Board** - Peripor is an expandable polystyrene (EPS) that is particularly suitable for applications exposed to compressive load. The most important properties of Peripor are:

- Excellent thermal insulation capacity
- High density – 45 kg/m³
- Outstanding impact absorption
- Low weight
- Imperviousness to moisture

2. **MAPEI waterproofing** - On Confluo Board is factory applied one of the most quality waterproofings, MAPELASTIC Turbo and MAPEBAND which guarantee 100% watertightness of our system.

3. **Dovetail Joint** - This method of joining the plates provides the strength of a joint that is resistant to all possible stresses. Also it prevent entering concrete between the plates.

4. **Time and cost effective** - A great benefit of the Confluo “Board” preinstall shower drains is that installation time and price is significantly reduced as a board have integrated slopes and applied MAPEI waterproofing.

5. **High Flow Rate** - System provides flow rate of 48l/min, which is in accordance with the highest standards.

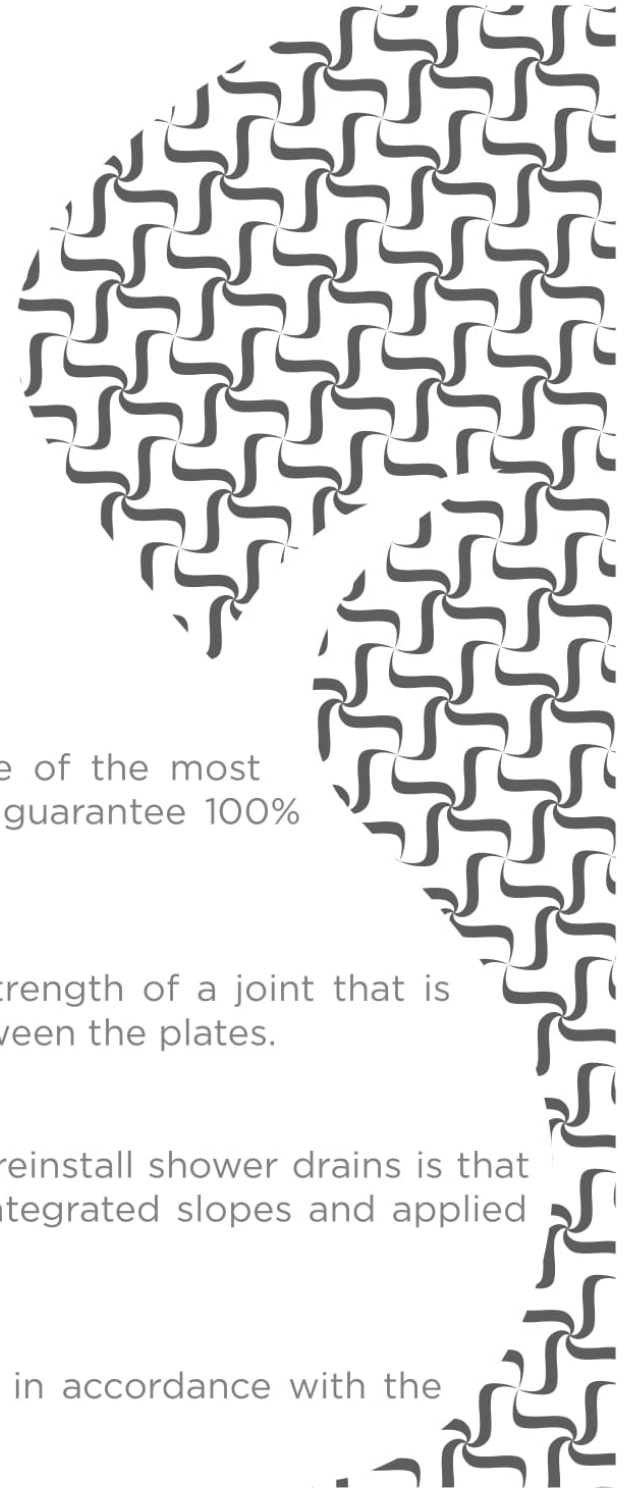



We produce our Confluo Board Frameless Line in 2 dimensions (900x900 mm & 1200x1200 mm) and a few board thicknesses, depending on whether you are renovating or making a new building. Product comes with 4 different 2 in 1 grid designs (Chrome/Ceramic, Black Glass/Chrome, White Glass/Chrome and Gold), 360 degrees rotatable S base with drainage capacity of 48 l/min and ALS - Anti-Leaking System. Our boards are made of high quality peripor with density of 45 kg/m³ with preinstalled slopes and it is coated with MAPELASTIC TURBO and MAPEBAND waterproofing.

Confluo **Board** **Frameless** Line

Main advantages:

- Peripor Board — 45 kg/m³
- MAPEI waterproofing
- Time and cost effective
- High Flow Rate — 48 l/min
- ALS — Anti-Leaking System

Board dimensions:

- 900X900X 80/95 mm
- 900X900X 38/52 mm
- 1200X1200X 80/95 mm
- 1200X1200X 35/54 mm

Grid Design

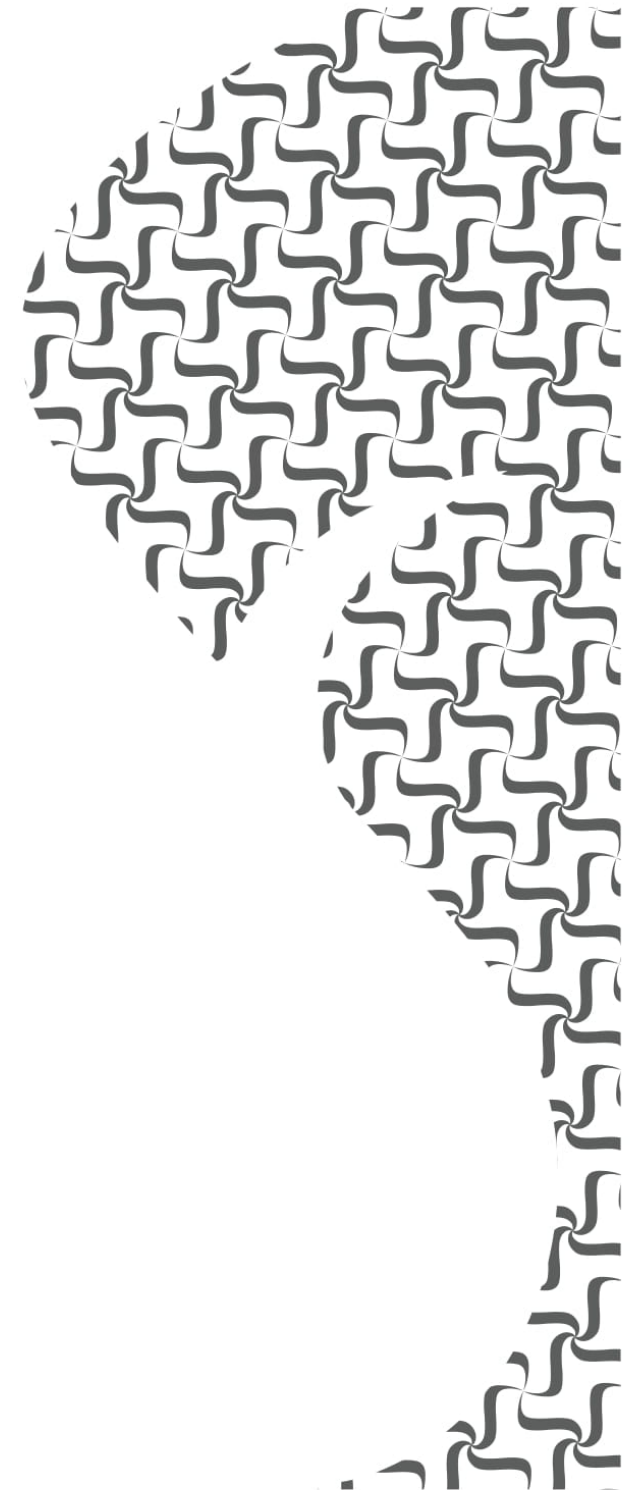

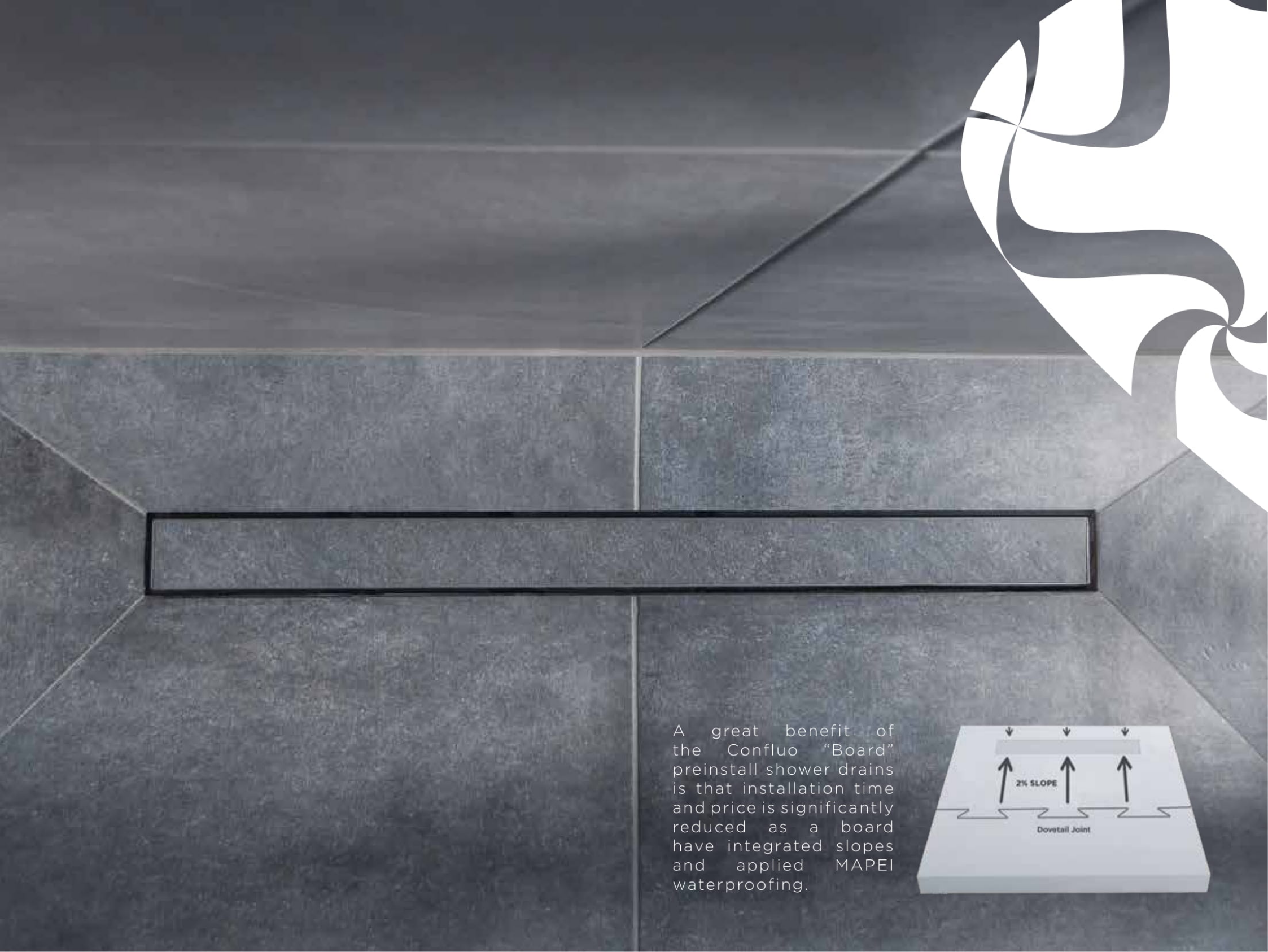

A great benefit of the Confluo “Board” preinstall shower drains is that installation time and price is significantly reduced as a board have integrated slopes and applied MAPEI waterproofing.

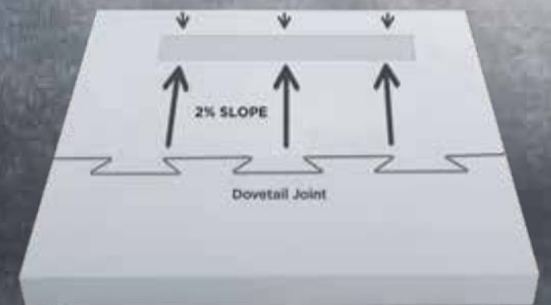

CONFLUO BOARD FRAMELESS LINE

BOARD FRAMELESS
900X900X 80/95

BOARD FRAMELESS
900X900X 38/52

BOARD FRAMELESS
1200X1200 80/95

BOARD FRAMELESS
900X900X 35/54

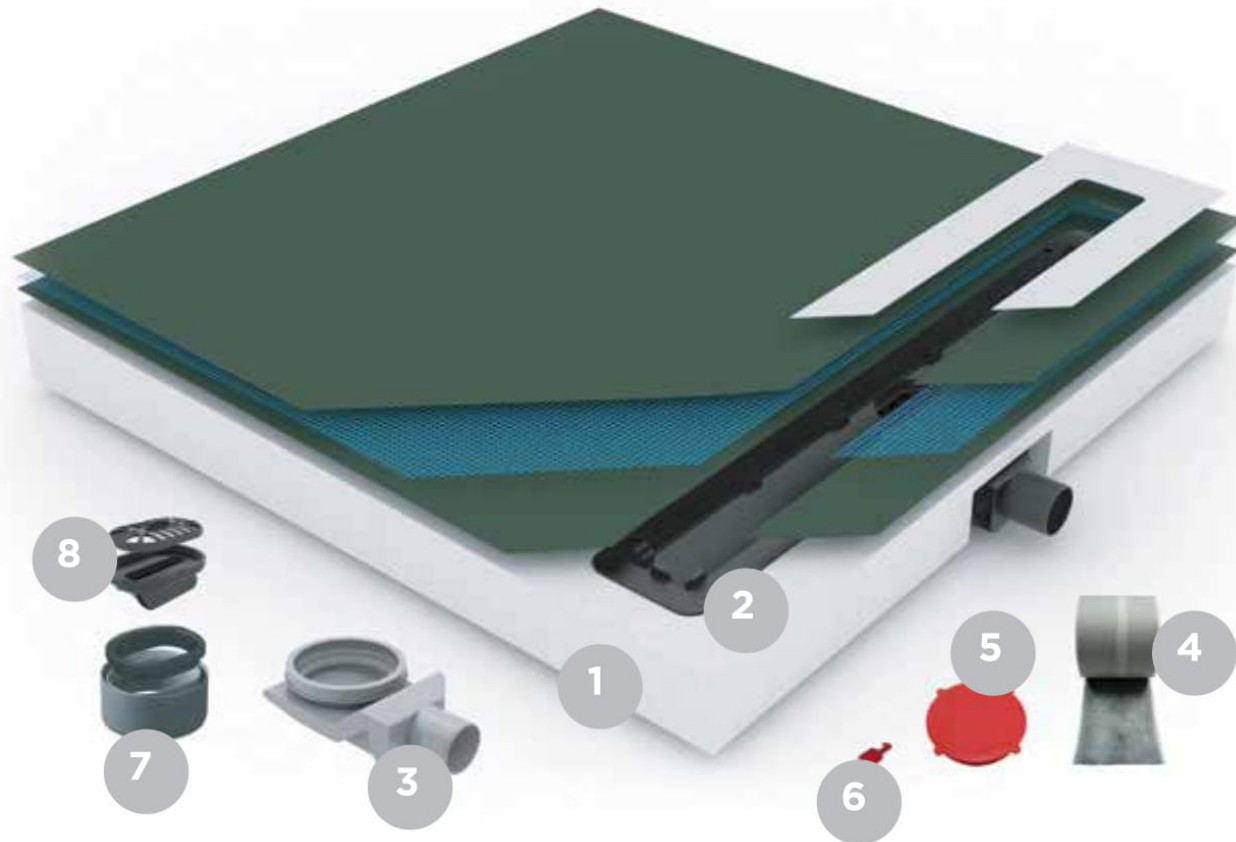

* Board and grid are sold separately

- In 1200x1200 mm Confluo Board is integrated Frameless Line 850 mm
- In 900x900 mm Confluo Board is integrated Frameless Line 750 mm

Legend:

1. Peripor board
2. Grid holder
3. Ultra low S base
4. MAPEBAND tape
5. Protective cap
6. Maintenance key
7. Reducer with rubber ring
8. Dry siphon

48l/min

Maximum flow rate

2 in 1
system

2 in 1 system

SC

Self-cleaning base

25
mm

Water seal height

K3

Load class of grid



Handicapped accessible

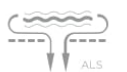

Anti-leaking system

Ø 50
output

Base diameter outlet

360°
base
rotation

Base rotation

AISI 304

Material of grid



Peštan offers more than 150 different models of Confluo Standard floor drains. All models have body made of plastic and grid made of stainless steel or glass, which we deliver in various designs and sizes + complete accessories and set for protection during the pouring of the concrete floor.

Confluo **Standard**

Main advantages:

- Minimum installation height — 56—78 mm
- Maximum flow rate — 48 l/min
- Unlimited leveling of ceramic
- Modularity — 5 different output options, 4 different siphons, 11 grid options
- Rotable — 360 degrees base rotation + 15 degrees angle rotation

Grid finish

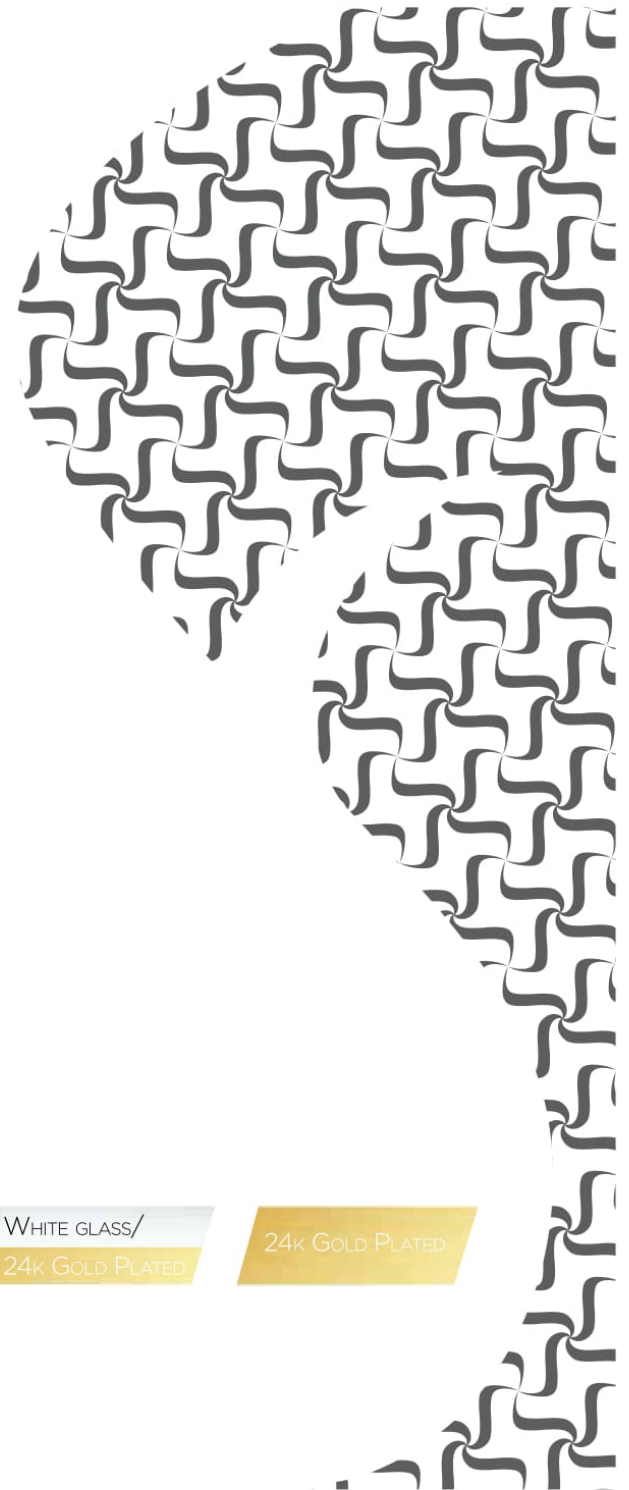

Types of Confluo **Standard** Grids



SQUARE 15x15



TIDE 15x15 AND 10x10

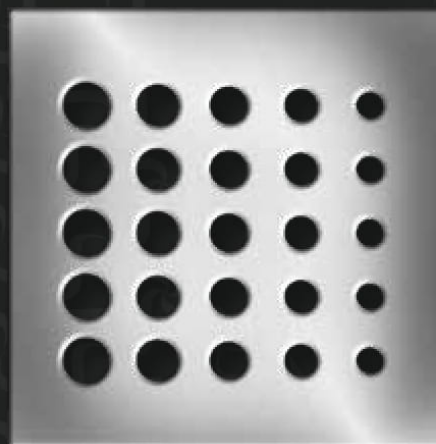

DROPS 15x15



ANGLE 20x20



BLACK GLASS
15x15 AND 10x10



WHITE GLASS
15x15 AND 10x10



CERAMIC
15x15 AND 10x10

Types of bases for Confluo **Standard** drains



BASE WITH
1 HORIZONTAL OUTLET



BASE WITH 1 HORIZONTAL
OUTLET/1 INLET



BASE WITH 1 HORIZONTAL
OUTLET/3 INLETS



VERTICAL BASE



S BASE WITH 28 MM OF WATER
SEAL AND ADJUSTABLE OUTPUT



S BASE WITH
25 MM OF WATER SEAL



Confluo **Standard** drains with metal grid

Models with 15x15 grid



Optional



Grid design

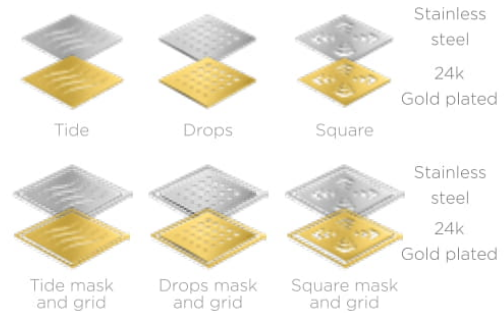

48l/min

Maximum flow rate

Ø50
 output
Base diameter outlet

Ø40
 inlet
Base inlet diameter

360°
 base rotation
Base rotation

easy access
Handicapped accessible

Models with 10x10 grid



Grid design

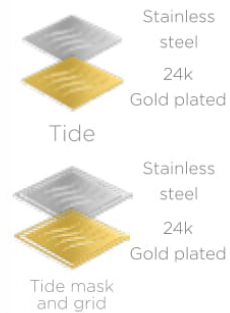

Fine output adjustment

Unltd
Ceramic adjustment

AISI 304
Material of grid



Confluo Standard Glass drains

Models with 15x15 grid



Models with 10x10 grid



Optional



Grid design

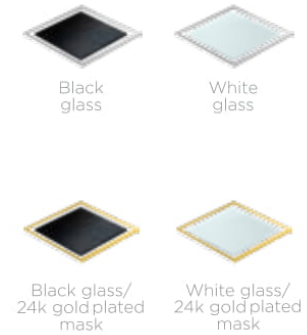

48l/min

Maximum flow rate

∅50
 output
Base diameter outlet

∅40
 inlet
Base inlet diameter

360°
 base rotation
Base rotation

easy access
Handicapped accessible

Fine output adjustment

Unltd
Ceramic adjustment



Confluo Standard Ceramic drains

Models with 15x15 grid

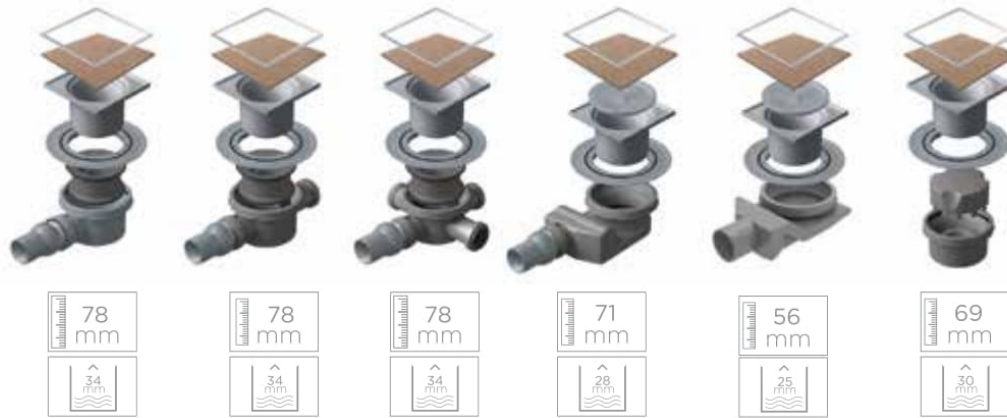

Optional



Grid design

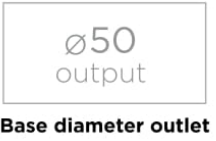
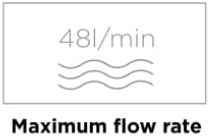
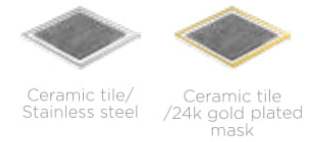

Models with 10x10 grid - Dry

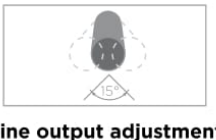



Confluo Standard Angle drains



Maximum flow rate

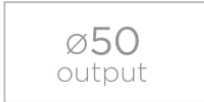

Base diameter outlet

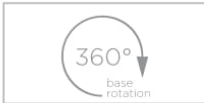

Base rotation



Handicapped accessible



Fine output adjustment



Ceramic adjustment



Material of grid

Models with 20x20 grid



Optional



Grid design





CONFLUO DESIGN by PEŠTAN

www.pestan.net

Confluo Gardino

SHAPE: Square
USAGE: Yards and open garage spaces
DETAILS: Square shape, small size of the frame, stainless steel, adjustable to the slope, modern design, functional

FEATURES:

- Simple model with good features
- Made of modern materials with high level of system security
- Keeps leaves out
- Maximum flow rate – 48 l/min
- Drainage add-on

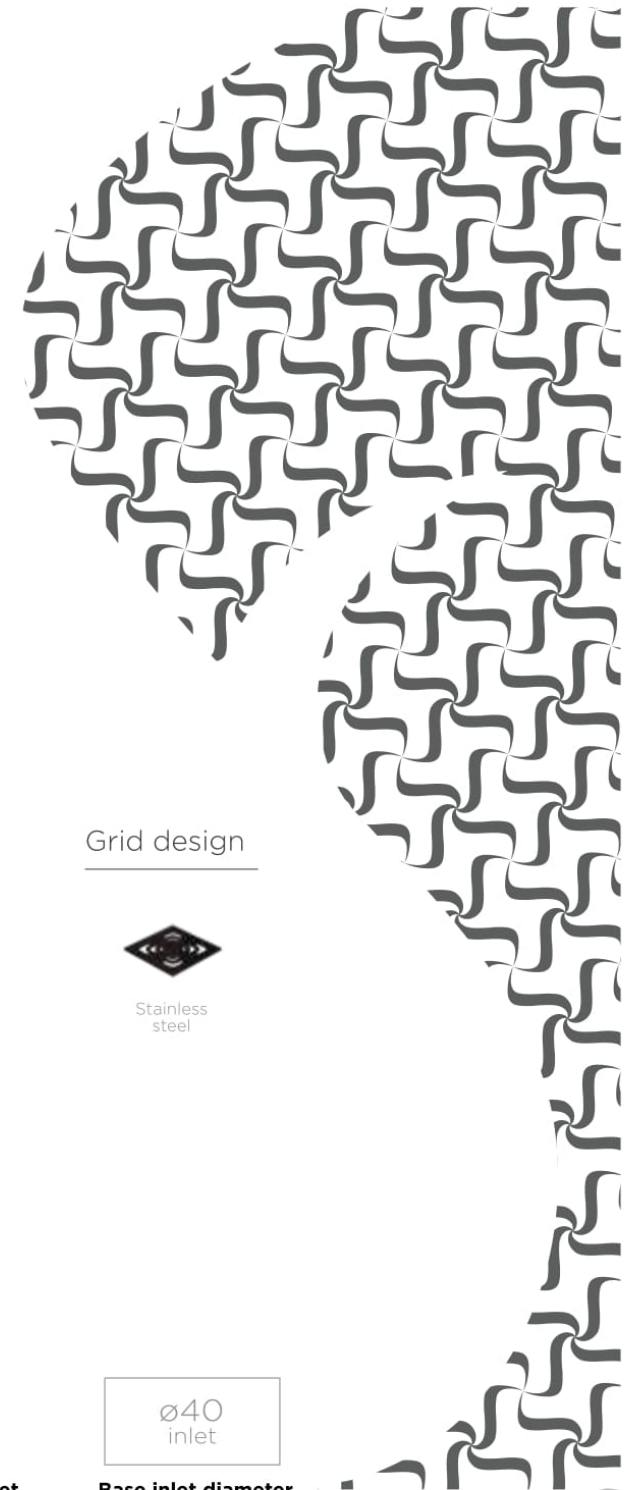

Models with 15x15 grid



Optional

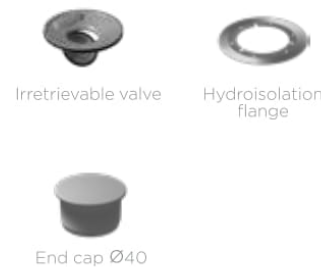

Grid design



Maximum flow rate



Base rotation



Handicapped accessible



Fine output adjustment



Base diameter outlet



Base inlet diameter



Confluo Top

SHAPE: Little cap

USAGE: Flat roofs

DETAILS: Small size of the frame, stainless steel, adjustable to the slope, modern design, functional

FEATURES:

- Simple model with good features
- Made of modern materials with high level of system security
- Keeps leaves out
- Maximum flow rate – 48 l/min

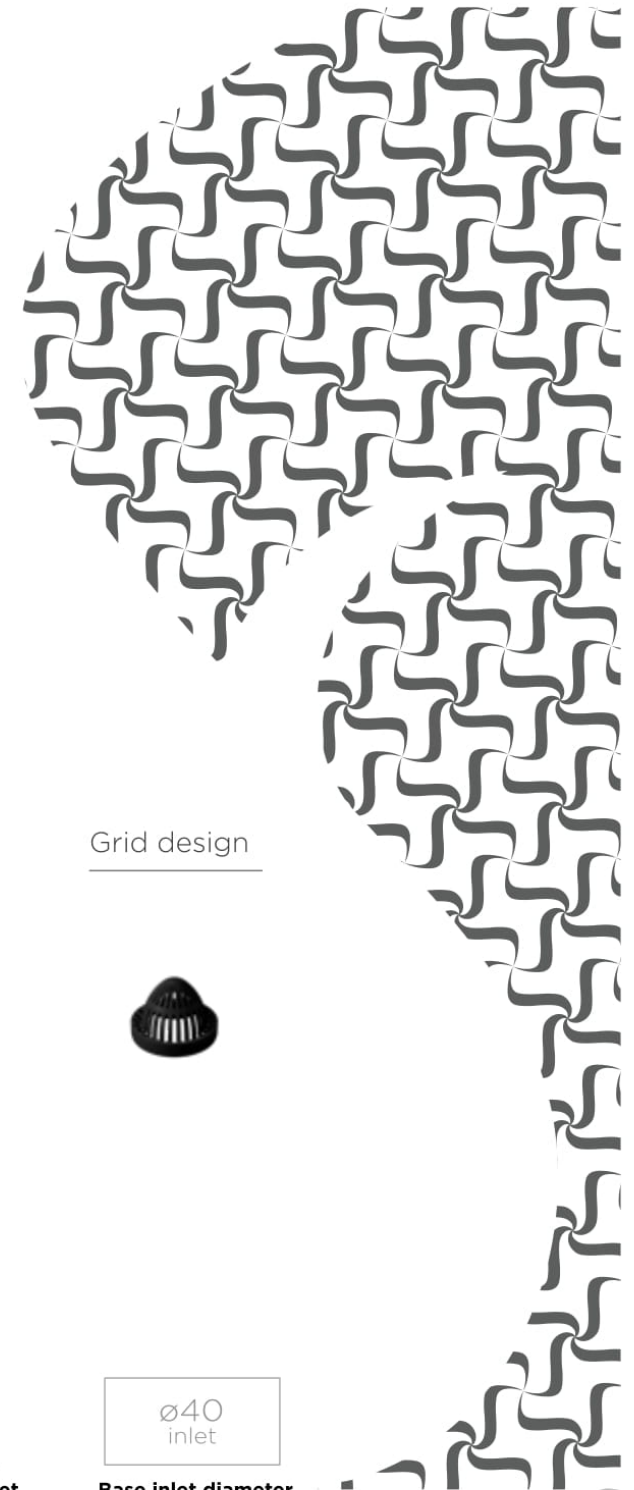

Models with 15x15 grid



78 mm

78 mm

78 mm

69 mm



Maximum flow rate

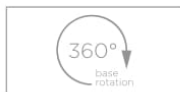

Base rotation



Handicapped accessible



Fine output adjustment



Base diameter outlet



Base inlet diameter

Optional



Grid design



Confluo POS Displays



Confluo
Big Display



Confluo Single
Display Premium



Confluo Single
Display Frameless



Confluo Single
Display Slim



Confluo Single
Display Wall

Confluo Webshop Packages

Listening to the needs of our associates, online shop owners, we have created webshop packages with the complete content needed to implement the Confluo range in any online store.

Webshop packages include:

- Photos of installed drains,
- Photographs and rendering of products and all drain elements,
- Text descriptions,
- Technical drawings and technical specifications for all products in the assortment.



Scan QR code for more info and download Confluo webshop packages.



MODULARITY

In order to satisfy the needs of our customers and achieve unlimited flexibility, we created Confluo drains with modular parts, which can be used on multiple products.

Base options:



BASE WITH
1 HORIZONTAL OUTLET



BASE WITH 1 HORIZONTAL
OUTLET/1 INLET



BASE WITH 1 HORIZONTAL
OUTLET/3 INLETS



VERTICAL BASE



S BASE WITH 28 MM OF WATER
SEAL AND ADJUSTABLE OUTPUT

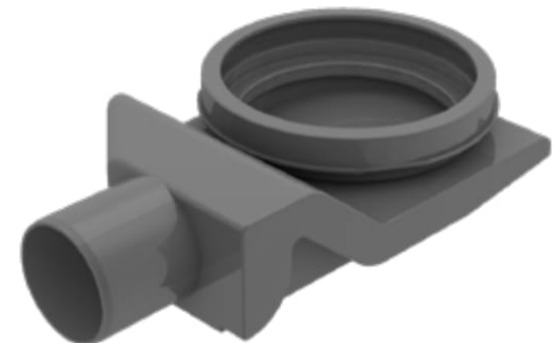

S BASE WITH
25 MM OF WATER SEAL

ADAPTERS



5 cm water seal adapter as per EN 1253



USA 2" vertical adapter for American plumbing p-trap systems made of ABS and PVC.



MENA DN 90, 75, 63, 50, 40 mm vertical adapter made of PP for plumbing systems with siphon in dropped ceiling.



MENA DN 50 MM VERTICAL ADAPTER







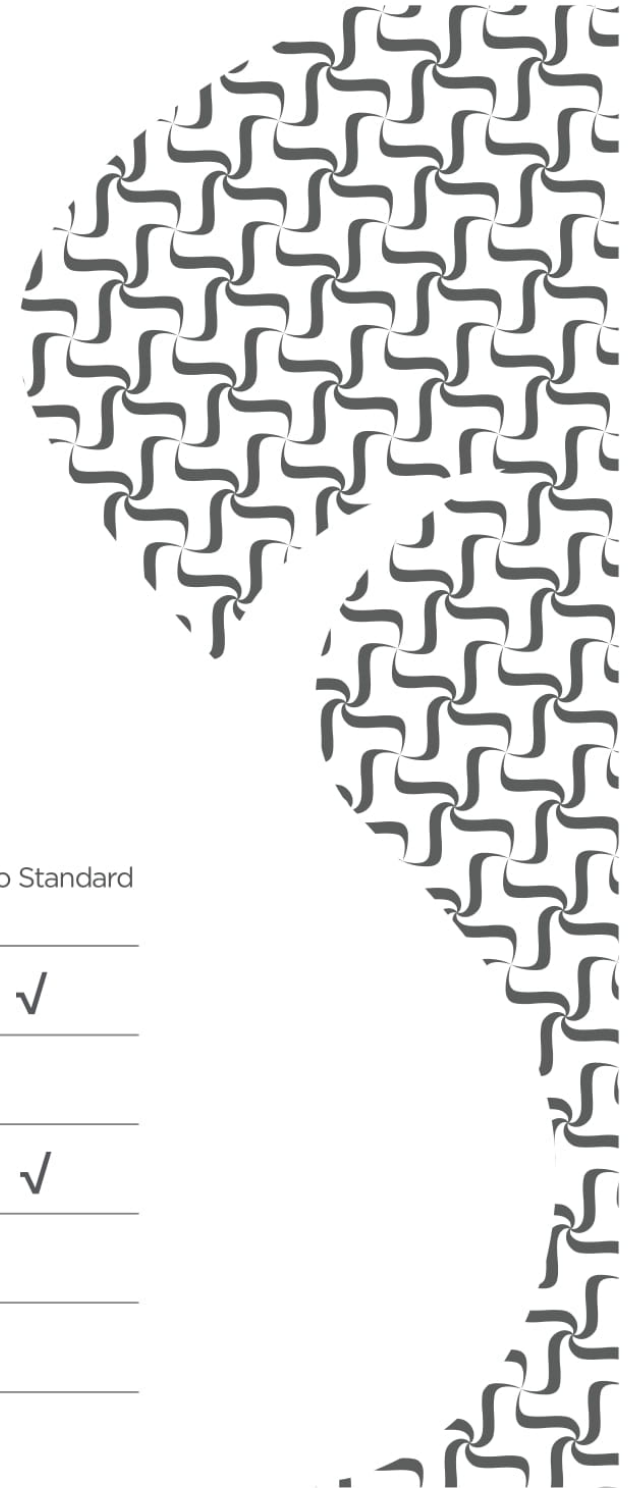

MENA DN 100 MM ADAPTER



HORIZONTAL S BASE 5 CM WATER SEAL



Compatibility of adapters with Confluo models:

	Confluo Premium Line	Confluo Frameless Line	Confluo Slim Line	Confluo Wall Drain	Confluo Standard
	✓	✓			✓
	✓	✓	✓	✓	
	✓	✓	✓	✓	✓
	✓	✓	✓	✓	
	✓	✓	✓	✓	
	✓	✓	✓	✓	

Content

03	WE ARE
04	INTRO
06	ICONS
07	TYPES OF CONFLUO DRAINS
08	ULTRA LOW S BASE
10	CONFLUO PREMIUM LINE
20	ANTI-LEAKING SYSTEM
22	CONFLUO FRAMELESS LINE
32	CONFLUO SLIM LINE
36	WALL DRAIN
42	CONFLUO BOARD
44	CONFLUO BOARD FRAMELESS LINE
48	CONFLUO STANDARD
52	CONFLUO STANDARD WITH METAL GRID
54	CONFLUO STANDARD GLASS
56	CONFLUO STANDARD CERAMIC
58	CONFLUO STANDARD ANGLE
60	CONFLUO GARDINO
62	CONFLUO TOP
64	WEBSHOP
65	POS DISPLAYS
66	MODULARITY
67	ADAPTERS

BRAND MANIFESTO

We do not only sell pipes, we combine reliability with quality for the ultimate benefit of our clients.

We do not build short-term client relationships, but long-term and genuine partnerships.

Everything we do, we do with one thing in mind — to create ideas to perfectly match all our client needs and the best way for us to achieve this goal is to constantly educate our clients provide solutions that meet their specific needs and support them throughout the entire process.

Because our success is as big as your trust in us.

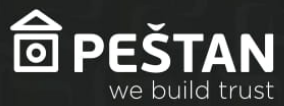

+381 034 700 300
OFFICE@PESTAN.NET

1300 KAPLARA 189
ARANDELOVAC
34300 SRBIJA



WWW.PESTAN.NET